

COMPANY DIRECTORY

version 21/10/2024

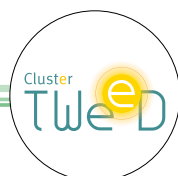

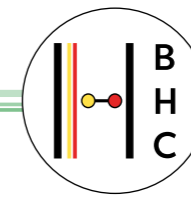
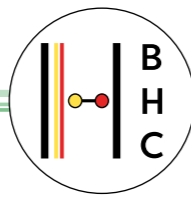

As president of the Board of the Belgian Hydrogen Council, Port of Antwerp-Bruges is honoured to present this company directory, an overview of Belgian hydrogen players. Within the Belgian Hydrogen Council, the whole hydrogen value chain is covered.

Already today vast amounts of hydrogen are consumed in industry, especially in the petrochemical cluster in Antwerp. In the coming years the clean hydrogen demand in refineries, chemical industry, steel industry and heavy duty mobility will increase, driven by decarbonisation targets and policy. This hydrogen originates today mostly from fossil sources, but in the coming years we will switch to renewable and low-carbon hydrogen fuels and feedstock. Some of this hydrogen or derivatives will be produced domestically. However, there isn't sufficient space, nor enough renewable energy available to meet Belgium's increasing hydrogen demand. Therefore, it is important to additionally import hydrogen from countries and regions with abundant renewable energy sources. Simultaneously, the previous international crises have demonstrated the importance of diversification to guarantee energy security in Europe. The diversification of various types of hydrogen from different regions will ensure this security of supply.

The high demand of hydrogen in Belgium has facilitated the current hydrogen infrastructure. The existing pipelines and terminals will undergo significant expansion and retrofitting in the coming years. This infrastructure will make easy hydrogen import in the ports and its subsequent transportation to local industrial clusters and neighbouring countries possible. Connecting this infrastructure to our neighbouring countries is vital, to supply for example the German industry with low-carbon and renewable hydrogen.

Another pivotal element in the hydrogen economy is technology. Belgium not only has key technology players in the realm of hydrogen production, transport, and storage, but many companies are also already implementing hydrogen technology and investing massively in innovative and pioneering R&D in this regard. For example, in the field of hydrogen combustion engines or electrolyzers, Belgium is a worldwide leader.

Together with its strategic geographical location, the existing logistics infrastructure, and the major industrial consumers, Belgium has many strengths to position itself as Europe's future hydrogen hub.

The Belgian Hydrogen Council is neither a federal nor a regional entity. The Council aligns with both regional and federal hydrogen strategies in Belgium, connecting various legislative levels. Consequently, the Belgian Hydrogen Council is ready to advise all these different levels with perspectives from all its diverse members, ranging from education to policy and infrastructure. Because only by joining forces we can realise the appropriate role of hydrogen as part of a more sustainable society.

Tom Hautekiet • President Belgian Hydrogen Council / CCO Port of Antwerp-Bruges

Geographical and infrastructural assets

Belgium has **four ports in a geographically very dense area, centrally located in Europe**, that will play a major role in developing the future hydrogen economy in the EU. We have world leading shipping companies that are looking to ship hydrogen derivatives, such as ammonia and methanol, across the globe to our ports. Several terminals for the reception of these hydrogen carriers and cracking installations for the reversion back to hydrogen, are under development in our ports. Furthermore, besides already hosting the second largest existing hydrogen pipeline network that connects industrial clusters in France, Belgium and the Netherlands, an open-access hydrogen network is under development in Belgium. This network will connect the different industrial clusters in Belgium, but also in the neighbouring regions, allowing our country to become a hub and gateway for the import & supply of renewable molecules for the rest of Europe, as we are already doing today for natural gas.

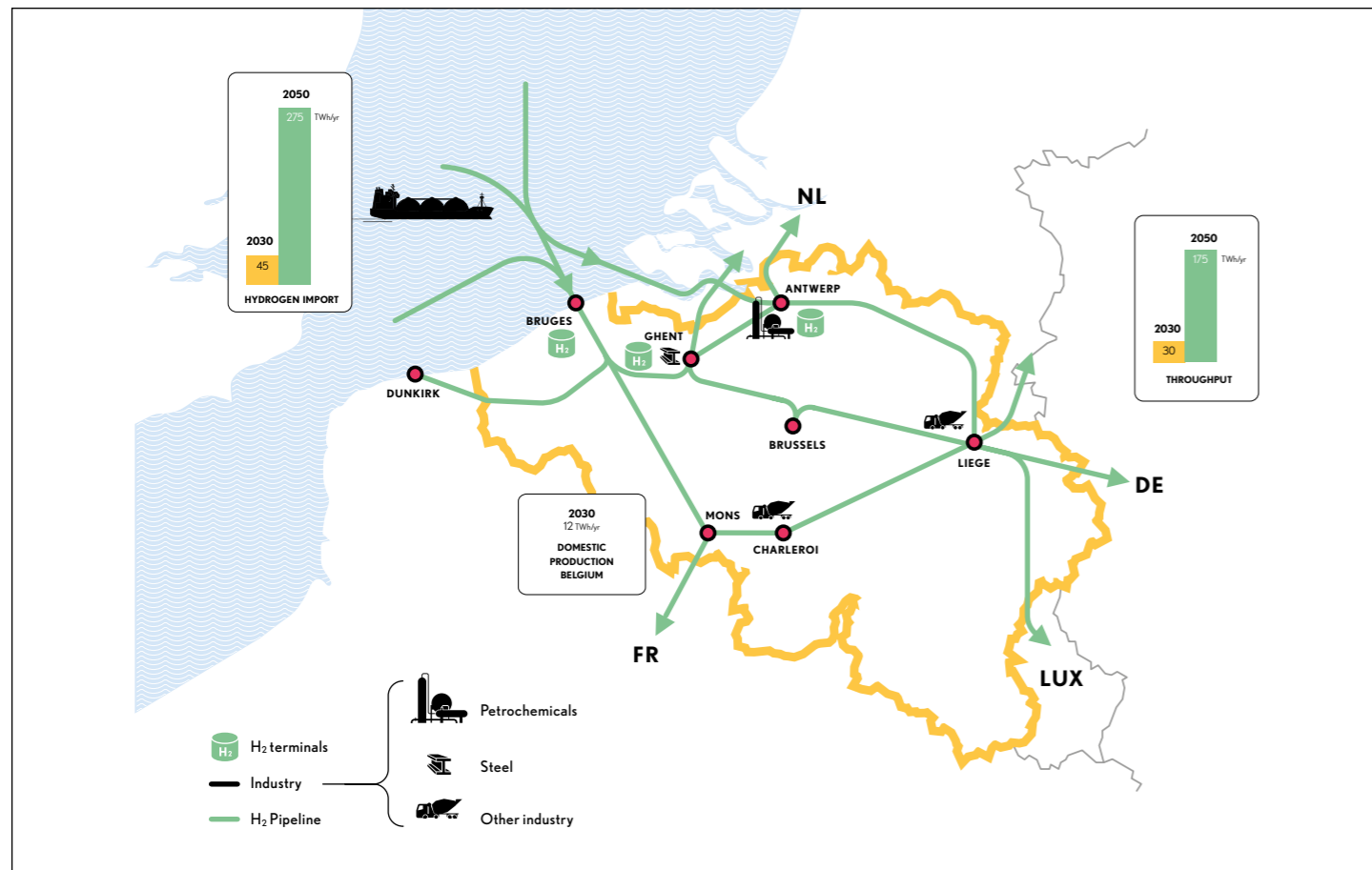

Large industrial consumers and innovative pioneering producers

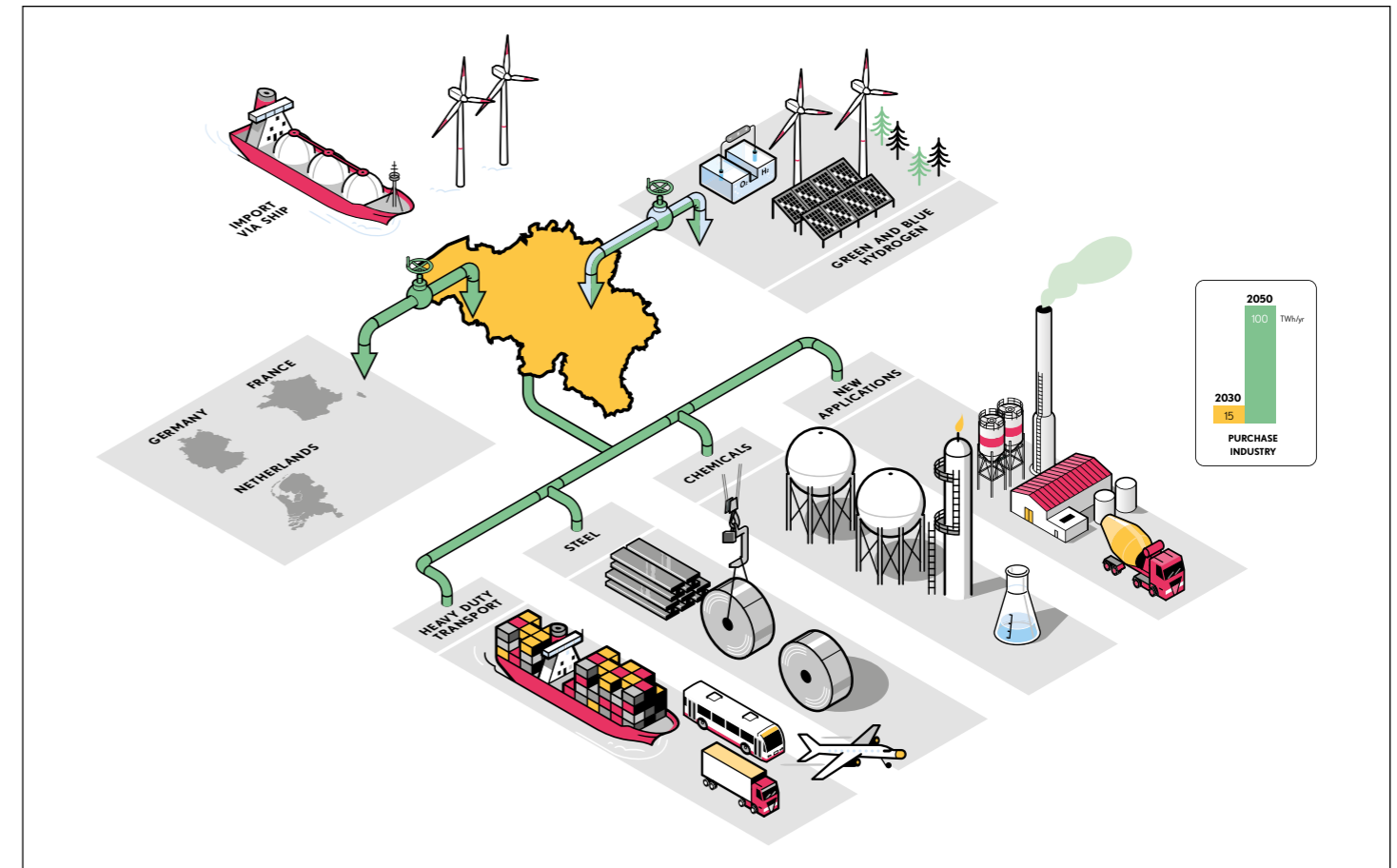

Demand for clean hydrogen is set to peak in our region. A BENELUX study shows that Belgium could require up to 600 Kton of green hydrogen every year by 2030 (e.g. an increase of 100-200 Kton in just a couple of years). Our country is home to the second largest petrochemical cluster in the world. This cluster today already consumes between 400 and 500 Kton of hydrogen every year. This consumption will be decarbonised following the companies' sustainability ambitions. Furthermore, Belgian steel industry is looking at clean hydrogen to decarbonise by replacing fossil cokes. The steel sector can thus potentially become a large consumer of clean hydrogen. In Wallonia, cement, lime, glass and fertilizer companies are looking at clean hydrogen to reduce their CO₂-footprint. In terms of heavy duty transport, Europe's logistics hotspot is formed by the triangle between Europe's largest seaports located in the Scheldt Delta and the Ruhr area, centered on Europe's largest fluvial port Duisburg. Nowhere in Europe the transport sector shows a higher concentration of heavy truck traffic, all looking at hydrogen to decarbonize the sector.

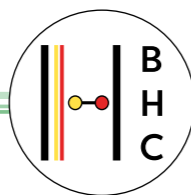

Despite Belgium's limited renewable energy production potential, some **innovative pioneering domestic clean hydrogen production** projects are underway. Aside from innovative projects using water and renewable electricity, also industrial projects are focussing on low-carbon-hydrogen (either through byproduct hydrogen or through application of Carbon Capture and Storage (CCS)). Our North Sea offers a promising green hydrogen production potential. In addition to this domestic production in Belgium, major Belgian industry players are involved in **large scale international projects** in a.o. USA, Brazil, Oman, Chile and Namibia, with other countries and international partnerships being explored.

Made in Belgium: hydrogen technology champions

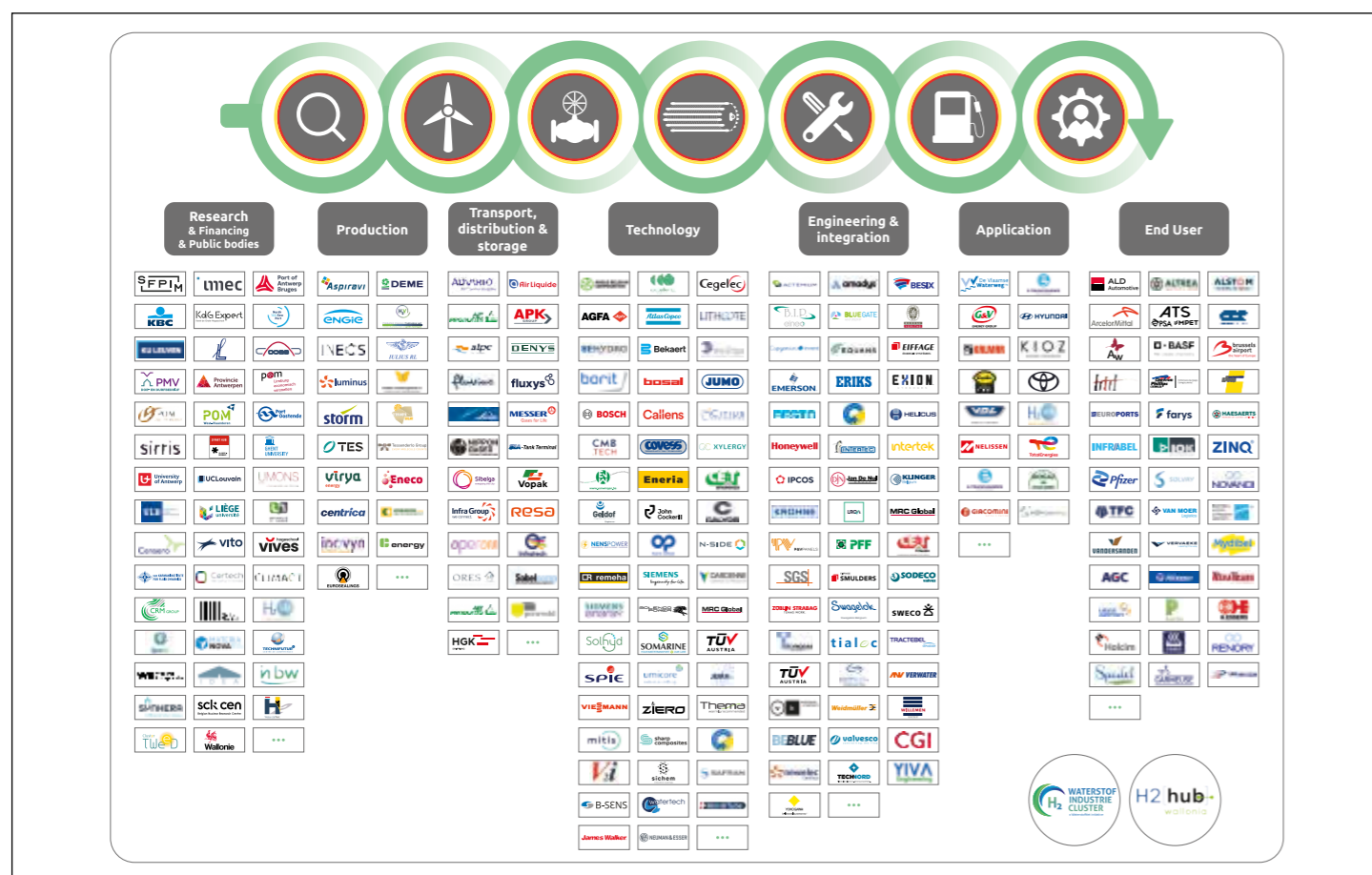

Belgium has all assets to play a major role in the production technology. We host **worldwide leading electrolyser manufacturers**. We are also world leaders in producing state of the art and innovative components to make these electrolysers more efficient, cost effective and durable. Membranes, bipolar plates, catalysts, porous transport layers - all crucial components of an electrolyser - are already being researched, developed and manufactured in Belgium and significant scaling up of the production capacities is currently being implemented.

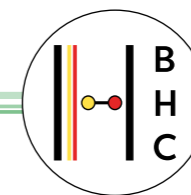

Belgium has a tradition of several decades when it comes to **combustion engines on hydrogen**. Started at universities, now major industrial companies are accelerating developments on using hydrogen in combustion engines. These companies are now applying this technology in trucks, tugs, excavators and others appliances. Buses, garbage trucks, trucks, fuelled by hydrogen are being manufactured in Belgium and deployed in other European countries for years. To support the rollout of the hydrogen transport economy, our country already counts five operational public hydrogen refuelling stations, with two more in the pipeline.

Our knowledge institutes are also firmly committed to hydrogen with **R&D activities, covering the whole value chain with research, development and techno-economic analysis**. This includes a vast variety of advanced materials analysis and research throughout the entire hydrogen value chain of applications (including a.o. innovation and testing on pipelines and high pressure storage). New concepts are being developed e.g. for direct hydrogen production out of sun. On the other hand, new processes are investigated for implementing hydrogen in industries such as steel, chemicals and cement. Serving the transport sector, a lot of R&D is being done on e.g. engines on hydrogen and a drive-train for using hydrogen in heavy-duty mobility. And the portfolio is still growing while the hydrogen economy develops.





Accelera by Cummins
<https://www.accelerazero.com/>
 Guillermo Idanez
guillermo.idanez@accelerazero.com

Our activities

Cummins is a global company headquartered in Columbus, Indiana, USA. Cummins designs, manufactures, distributes, and services a broad portfolio of power solutions ranging from diesel, natural gas, electric and hybrid powertrains to powertrain-related components as well as generator sets.

Cummins began developing its fuel cell capabilities more than 20 years ago and the acquisition of Hydrogenics in 2019 accelerated Cummins' ability to further innovate and scale hydrogen technologies across a range of commercial markets. Owning both fuel cell and hydrogen generation from electrolysis capabilities enables us to offer a full, differentiated hydrogen solution, from start to finish, seamlessly integrated for customers.

8 March 2023 Cummins launched the brand Accelera by Cummins. Accelera provides a diverse portfolio of zero-emission solutions for the world's most economically vital industries, empowering them to accelerate the transition to a sustainable future. Accelera, a business segment of Cummins, is both a components supplier and integrator, focused on batteries, hydrogen fuel cells, e-axes, traction systems and electrolyzers.

Accelera currently has operations in North America, across Europe and in China.

Our link with hydrogen

- Hydrogen plays a key role as part of Destination Zero, our strategy for reaching zero emissions, including near-term 2030 goals. We believe green hydrogen will be critical to a decarbonized future, particularly for hard-to-abate sectors. To dramatically reduce greenhouse gas emissions and meet demanding climate targets, we are investing now in scaling electrolyzer manufacturing across all Accelera sites in Belgium, Spain, North America and China.



○ Research & Training ○ Production ○ Transport, dist & storage ● Technology ○ Application ○ Engineering & integration ○ End User

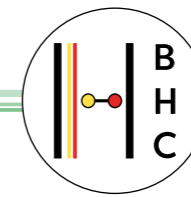
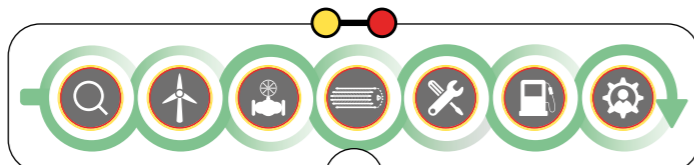

Agfa-Gevaert NV
www.agfa.com/zirfon
 Nick Valckx
nick.valckx@agfa.com

Our activities

Agfa is a global leading company in imaging technology and IT solutions with over 150 years of experience. It develops solutions for the healthcare sector, the printing industry, and specific industrial applications.

Agfa is committed to advancing the shift toward sustainable energy. Contributing to this are Agfa's ZIRFON membranes to produce green hydrogen for industrial processes, energy storage, fuel, heating, or ammonia production.

Green hydrogen is produced via water electrolysis, a process that uses zero-carbon electricity to split water into hydrogen and oxygen, which are then kept separate by a membrane. Agfa's ZIRFON membranes are the most cost-effective technology for hydrogen production. They offer exceptional productivity, 4 times higher than conventional membranes, and outstanding durability, enhancing the efficiency and reliability of electrolytic systems, while limiting maintenance.

Over 100 companies worldwide are already utilizing ZIRFON membranes for large-scale hydrogen projects. To meet the growing demand, Agfa is expanding production capabilities. A new industrial unit in Mortsel, Belgium, will be able to produce up to 20 GW/year of electrolyser capacity – enough to prevent 50 million tons of CO2 emissions.

Our link with hydrogen

- With its highly productive and durable ZIRFON membranes for green hydrogen production, Agfa makes green hydrogen affordable, thus contributing to the global shift toward sustainable energy and decarbonization.



○ Research & Training ● Production ○ Transport, dist & storage ○ Technology ○ Application ○ Engineering & integration ○ End User

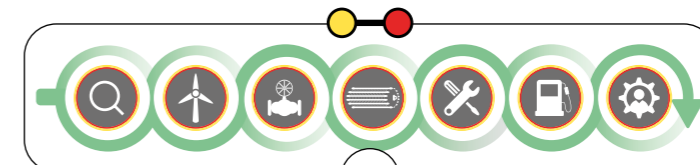



AIR LIQUIDE
<https://www.airliquide.com/>
 Christophe Galimont
 christophe.galimont@airliquide.com

Our activities

A world leader in gases, technologies and services for Industry and Health, Air Liquide is present in 73 countries with approximately 67,100 employees and serves more than 3.9 million customers and patients. Oxygen, nitrogen and hydrogen are essential small molecules for life, matter and energy. They embody Air Liquide's scientific territory and have been at the core of the company's activities since its creation in 1902.

Thanks to its unique hydrogen expertise developed in industry (space, aeronautics, heavy industry) over the last 60 years, Air Liquide masters the entire value chain: production, transport, storage and distribution. This unique positioning and technological expertise, particularly in extreme cryogenics, makes Air Liquide a key worldwide player in the implementation of hydrogen projects to decarbonize industry and mobility.

The Air Liquide Group has a strong and long-term (more than 100 years) presence in Belgium, and considers Belux as one of its key strategic basins. The organization is very active in developing large-scale and pioneering decarbonization projects, for instance in the fields of hard-to-abate industries (Kairos@C) or heavy-duty mobility (HyTrucks).

Our link with hydrogen

- The Air Liquide Group is a hydrogen expert for more than 60 years and believes this molecule will be key to achieving energy transition by making it possible to meet two major challenges : decarbonizing heavy industry and revolutionizing clean mobility.



○Research & Training ○Production ●Transport, dist & storage ○Technology ○Application ●Engineering & integration ○End User

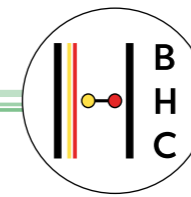
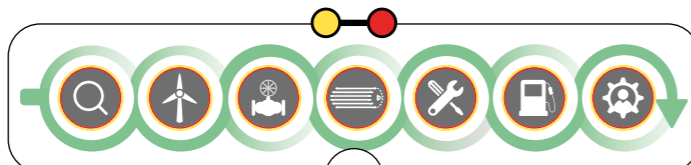

Amadys NV
www.amadys.com
 Roel Michaux
 roel.michaux@soper.be

Our activities

Amadys is a leading company in providing passive equipment for the telecom and energy sector. The company has a strong local presence in Belgium, the Netherlands, Germany, the UK, Denmark, Austria, Slovakia and Hungary. As a system integrator in providing end-to-end connectivity solutions for telecom, electricity, water, gas & industry, Amadys offers a one-stop solution to its customers in 8 European countries. Thanks to the extensive know-how of more than 450 employees and 50,000 square meters of warehouse space, Amadys realizes highly reliable networks combined with fast deliveries. This results in an annual turnover of more than 450 million euros.

In the realm of water management, the company engages in the design and implementation of advanced distribution systems. In the domain of electricity, the company excels in deploying cutting-edge electrical infrastructure. Within the gas sector, the company leverages its expertise to develop robust gas distribution networks. This involves the installation of pipelines, pressure regulation equipment, and safety systems to facilitate the reliable and safe delivery of gas to end-users.

Our link with hydrogen

- Amadys is at the forefront of hydrogen technology, pioneering the installation of hydrogen production, distribution and storage facilities.



○Research & Training ○Production ●Transport, dist & storage ○Technology ○Application ●Engineering & integration ○End User

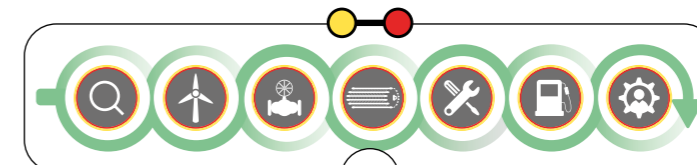



Anglo Belgian Corporation
www.abc-engines.com
 Koen Christianen
kc@abc-engines.com

Our activities

ABC, founded in 1912 in Ghent, is a leading manufacturer of medium-speed internal combustion engines, with a power range from 600 kW to 10.5 MW per engine. Our innovative power generation solutions are utilized in heavy-duty applications across the globe, including shipping, locomotives, power generation, and power plants.

With over 110 years of international experience in engine manufacturing, ABC possesses exceptional expertise and competence. Our stability is bolstered by our strategic geographical location at the intersection of major logistics routes, coupled with a robust structure that perpetuates passion, knowledge, and entrepreneurship from one generation to the next. Our core strength lies in delivering tailored solutions to address our customers' unique challenges.

At ABC, research and innovation play a central role. We place significant emphasis on durability, reliability, and the simplicity of our engine designs. Our specialization focuses on developing internal combustion engines running on alternative fuels, with a specific focus on minimizing the CO2 footprint. Our goal is to engineer the most efficient engines that generate greater power while consuming less fuel, ultimately achieving zero emissions.

Our link with hydrogen

- Under the name BeHydro, a joint venture with Antwerp-based family company CMB.TECH, ABC markets innovative hydrogen internal combustion engines. The BeHydro engine range includes both dual fuel and 100% hydrogen engines with zero emissions in a power range from 600 kW up to 2.7 MW (3,700 hp).



○Research & Training ○Production ○Transport, dist & storage ○Technology ●Application ○Engineering & integration ○End User

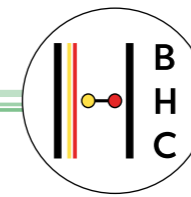
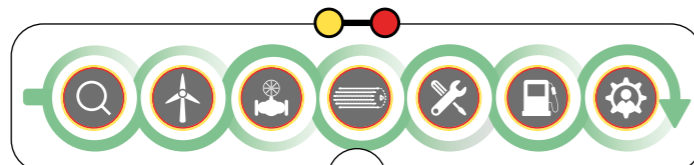

ArcelorMittal Industeel
<https://industeel.arcelormittal.com/>
 Baudouard Anne-Cécile
anne-cecile.baudouard@arcelormittal.com

Our activities

ArcelorMittal is the largest steel and mining company in America (North and South) and Europe. At ArcelorMittal, our goal is to help build a better world with smarter steels. Steels made using innovative processes which are more efficient, use less energy, and emit significantly less carbon. Steels that are cleaner, stronger and reusable. Steels for electric vehicles and renewable energy infrastructure that will support societies as they transform through this century).

Industeel is a business unit of ArcelorMittal and produces heavy plates for customers all over the world. As Europe's leading supplier of quarto plates in alloy or stainless steel, Industeel is specialized in almost all industrial sectors but mainly Global Energy Transition with innovative solutions.

Industeel produces steel exclusively from recycled steel. Despite our already very positive results in the steel industry due to our manufacturing process, Industeel is committed to working with ArcelorMittal to reduce CO2 emissions by 35% by 2030.

Using Hydrogen instead of Natural Gas in our process is one of the lever identified in our decarbonization roadmap to reach our reduction CO2 emissions objective.

Our link with hydrogen

- Hydrogen is one of the alternativ to natural gas in our preheating process before rolling and heat treatment processes and could lead to avoid 20kTo CO2 per year from 2030



○Research & Training ○Production ○Transport, dist & storage ○Technology ○Application ○Engineering & integration ●End User

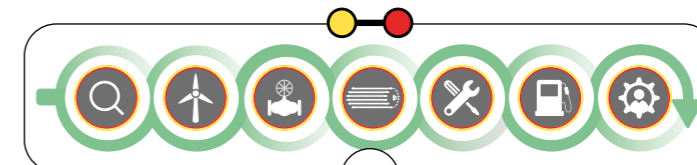



Associated Weavers Europe N.V.
<https://www.carpetyourlife.com/>
 Michel Van Campenhout
 michel.van.campenhout@awe.be

Our activities

Associated Weavers (AW) is part of Belgotex International group of companies and is one of the biggest producers of tufted broadloom carpet in Europe.

The company is headquartered in Ronse, in East Flanders, Belgium.

Key figures:

- about 650 employees
- 20 million m² carpet yearly
- €160 million revenue

Our link with hydrogen

- Our production process is mainly running on the combustion of natural gas.
- AW considers hydrogen to be part of the solution in our effort to decarbonize our production process.



○Research & Training ○Production ○Transport, dist & storage ○Technology ○Application ○Engineering & integration ●End User

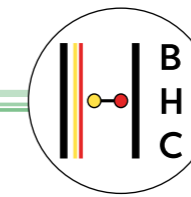
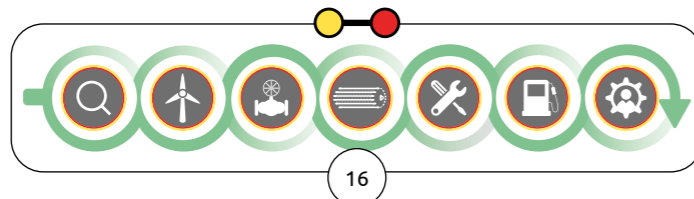

Atlas Copco
www.atlascopco.com
 Hans Magits
 hans.magits@atlascopco.com

Our activities

Atlas Copco is a global player in the delivery of industrial productivity solutions. We offer our customers peace of mind. Our market-leading compressors, vacuum solutions, generators, pumps, power tools and assembly systems are critical for their performance, and our high-quality service offering ensures they get the most out of every investment. By proactive service, mainly through connected and digital solutions, our skilled service engineers make sure our customers' production run smoothly at all times.

One of our highest priorities is to develop innovative products and service solutions with a life-cycle perspective. We design products that provide tangible benefits in terms of productivity, energy efficiency and/or lower life cycle cost for the customer. We constantly set new industry standards and want to be world-leading in everything we do. We live by the highest ethical standards, with a zero tolerance for corruption.

Atlas Copco sees hydrogen as a key driver in powering the energy transition, with the goal of reaching net-zero emissions. Atlas Copco has the technology and the products today to help our customers reduce environmental emissions and make a circular, sustainable economy a reality.

Our link with hydrogen

- Atlas Copco sees hydrogen as a key driver in powering the energy transition, with the goal of reaching net-zero emissions. Atlas Copco has the technology and the products today to help our customers reduce environmental emissions: hydrogen products for Mobility, Power-to-Gas and Feedstock applications.



○Research & Training ○Production ●Transport, dist & storage ○Technology ○Application ○Engineering & integration ○End User

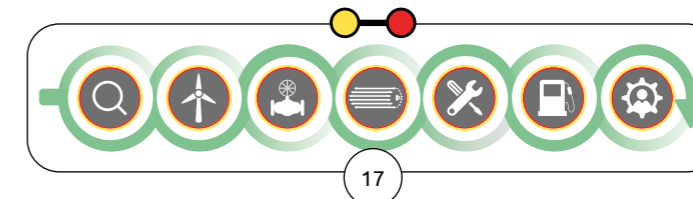



Ballast Nedam Industriebouw B.V.
www.industriebouw.ballast-nedam.nl
 Wouter Koster/ Commercial manager
 W.Koster@ballast-nedam.nl

Our activities

Ballast Nedam Industriebouw is a major player and contributes as a multi-disciplinary contractor in renewable energy projects in Belgium and The Netherlands. Ballast Nedam Industriebouw B.V. is involved in building new-energy assets and can provide total solutions for the Industrial market.

For Mobility projects, Ballast Nedam achieved in 2013 a significant milestone by collaborating with Waterstofnet to establish the first hydrogen station in The Netherlands. It marked the beginning of a new era of environmentally friendly fuel solutions.

Our link with hydrogen

- Ballast Nedam Industriebouw is actively involved to the energy transition. We contribute to the energy transition by realizing multiple green developments.



○Research & Training ○Production ○Transport, dist & storage ○Technology ●Engineering & integration ○Application ○End User

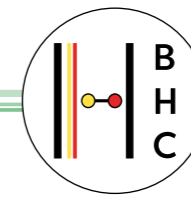
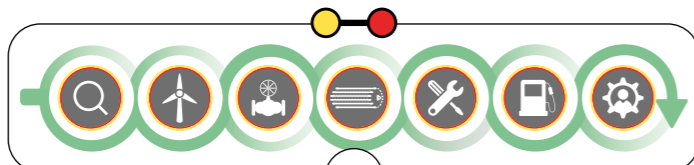

BASF Antwerpen
www.basf.com/be/nl/who-we-are/Group-Companies/BASF-Antwerpen.html
 Sandra Wauters
 sandra.wauters@basf.com

Our activities

BASF Antwerp is located in the northernmost part of the port of Antwerp. It is the largest chemical production site in Belgium and the second largest BASF group site in the world.

The company's product range includes basic chemicals and specialty chemicals, plastics and precursors, finishing products and inorganics. The products of BASF Antwerp are used in almost all processing sectors.

BASF has set ambitious CO2 reduction targets: reduce the CO2 emissions with 25% by 2030 (compared to 2018) and net zero CO2 emissions by 2050 (scope 1 and 2 emissions). BASF Antwerp will significantly contribute to these objectives.

Hydrogen is an essential raw material for the chemical industry at large, and thus for BASF Antwerp. Currently, most of the hydrogen is produced using processes with relatively high CO2 emissions. Reducing these emissions will be critical for the transformation of chemical manufacturing. Technologies for the production of clean hydrogen include water electrolysis, methane pyrolysis, and conventional steam reforming combined with the use of carbon capture and storage. Climate friendly chemistry based on clean/ emission-free hydrogen will require large amounts of reliable renewable energy at competitive prices and the rapid creation of an efficient infrastructure to enable transfer within the EU and beyond.

Our link with hydrogen

- Hydrogen is an essential raw material for the chemical industry at large, and thus for BASF Antwerp. Currently, most of the hydrogen is produced using processes with relatively high CO2 emissions. Reducing these emissions will be critical for the transformation of chemical manufacturing. Technologies for the production of clean hydrogen include water electrolysis, methane pyrolysis, and conventional steam reforming combined with the use of carbon capture and storage. Climate friendly chemistry based on clean/ emission-free hydrogen will require large amounts of reliable renewable energy at competitive prices and the rapid creation of an efficient infrastructure to enable transfer within the EU and beyond.



○Research & Training ●Production ○Transport, dist & storage ○Technology ○Engineering & integration ●Application ●End User

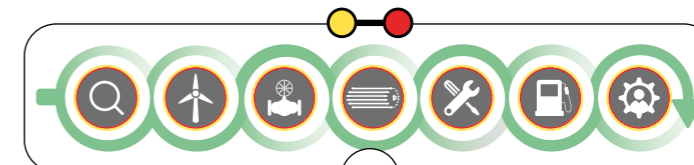



BEBLUE

BEBLUE
<https://www.beblue.be>
Jérôme d'Agruma
jerome.dagruma@beblue.be

Our activities

Beblue proposes testing capabilities with cryogenic fluids, such as liquid or gaseous hydrogen, oxygen and nitrogen. It is one of the 4 strategic ESA test centers with more than 3 decades expertise in cryo testing.

Beblue offers material characterization, components & systems testing in real environments, and engineering expertise.

Material characterization includes Pin On Disk / Impact/Auto-Ignition/ Adiabatic compression/ traction & endurance cycling (@20K).

Complex components testing of E-Pump, valves, bearing, dynamic seal, composite tank, fuel cells is performed in real conditions.

Beblue is specialist in cryo-tribology, test rig design, test rig integration, test management.

Our link with hydrogen

- Development of new materials
- Fuel cell testing in real environment up to 250KVA
- Hydrogen systems like composite tanks, valves, lines, seals, heat exchanger



○Research & Training ○Production ○Transport, dist & storage ●Technology ●Engineering & integration ○Application ○End User

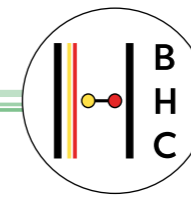
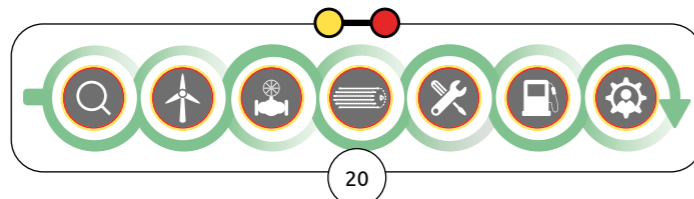

BEHYDRO

BeHydro
www.behydro.com
Koen Christianen
kc@abc-engines.com

Our activities

BeHydro, a joint venture between ABC and CMB.TECH, brings together the expertise of two Belgian, family-owned companies to address the pressing need for clean technologies in various industries, incl. shipping, railway, and power generation. By combining the skills of a premium engine manufacturer with the insights of a leading clean-tech company, BeHydro is committed to delivering top-notch solutions for these demanding sectors.

At the heart of BeHydro's mission is the development and marketing of cutting-edge hydrogen ICEs. Specializing in H₂-powered engines, BeHydro offers a diverse product portfolio that includes both dual-fuel and 100% H₂ ICEs, all boasting zero emissions.

With a power range spanning from 600 kW to an impressive 2.7 MW, BeHydro's engines are designed to cater to a wide array of heavy-duty applications.

BeHydro's dedication to sustainability is evident in its commitment to hydrogen as a clean energy source, contributing to the reduction of GHG emissions and the fight against climate change. By promoting the adoption of H₂ technology as a reliable and efficient alternative to ICE's using traditional fuels, BeHydro actively contributes to a greener and more sustainable future for industries worldwide

Our link with hydrogen

- BeHydro, a joint venture between ABC and CMB.TECH, is focused on pioneering hydrogen internal combustion engines to provide sustainable and zero-emission solutions for heavy-duty industries like shipping, railway, and power generation. Their commitment to hydrogen technology stems from a dedication to reducing greenhouse gas emissions and advancing sustainable energy solutions, offering an efficient alternative to internal combustion engines using traditional fuels.



○Research & Training ○Production ○Transport, dist & storage ○Technology ○Engineering & integration ●Application ○End User

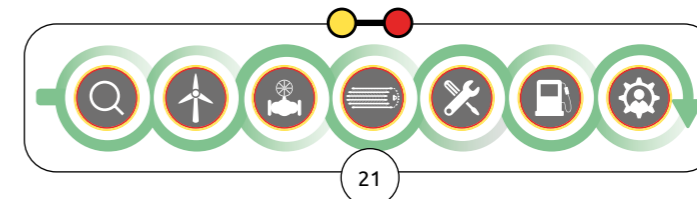



Bekaert
www.bekaert.com
 Chris Dhulst
chris.dhulst@bekaert.com

Our activities

Shape the world with creativity beyond steel

As a global market and technology leader in material science of steel wire transformation and coating technologies, Bekaert also applies its expertise beyond steel to create new solutions with innovative materials and services

Driving the energy transition :

Bekaert steps up as key enabler of the energy transition by providing the necessary solutions from hydrogen production all the way to final demand :

- Bekaert is already a leading component supplier worldwide of Porous transportation layers, including the US, under the brand name Currento®
- A Bekaert-led consortium will accelerate demonstration of steel reinforced flexible pipes for hydrogen transmission.
- Bekaert is offering multiple other solutions for the clean-energy sector, ranging from floating offshore wind turbine mooring lines (with strategic US partnerships in research & local production facilities) – to armoring solutions for offshore wind farm connections to shore, reinforcement of hydrogen filling station hoses, and hydrogen burner solutions for heating.

Our link with hydrogen

- With a track record of more than 20 years in electrochemical applications, Bekaert is already a leading component supplier worldwide of Porous transportation layers, including the US, under the brand name Currento® - Supported by the Belgian Federal Government and the EU Recovery and Resilience Facility, a Bekaert-led consortium will accelerate demonstration of steel reinforced flexible pipes for hydrogen transmission.

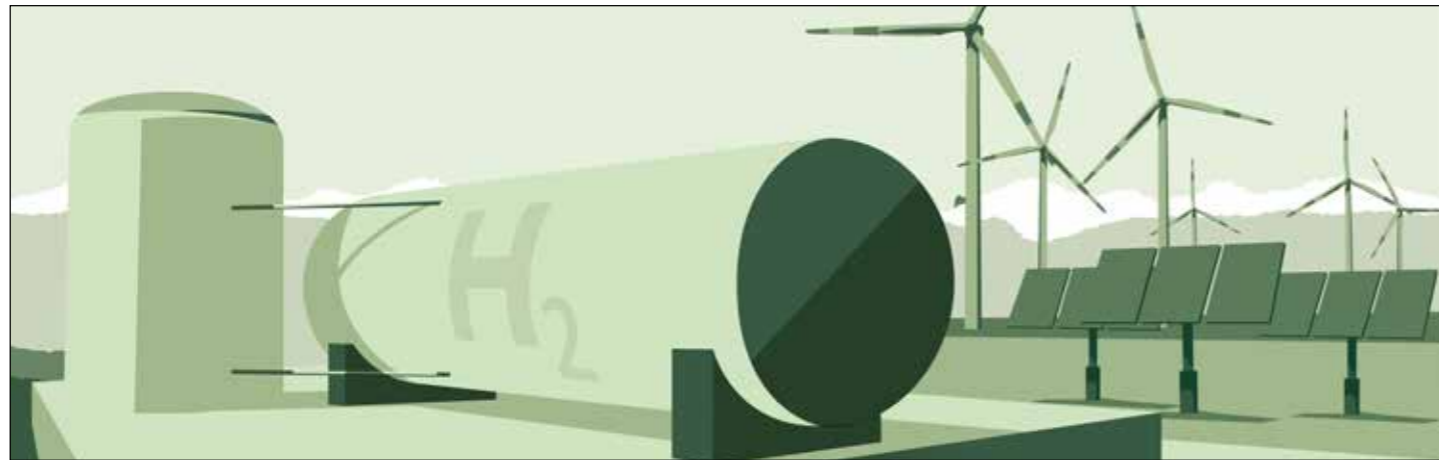

○Research & Training ●Production ●Transport, dist & storage ●Technology ○Engineering & integration ●Application ○End User

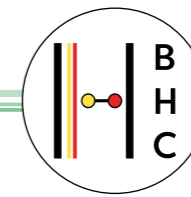
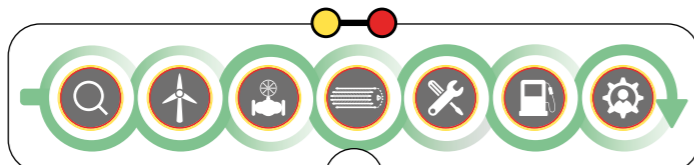

BESIX
<https://www.besix.com>
 Adrien Theunissen
adrien.theunissen@besix.com

Our activities

Since its incorporation more than 100 years ago, BESIX Group has evolved into a multidisciplinary company with a leading position in its markets: construction, infrastructure and marine works, waste and water treatment, hydro power, cable and pipeline construction, etc. The synergies between the Group's entities enable BESIX to bring value to every aspect of a project, from financing over designing and building to operations and maintenance.

Backed by the experience in the home markets, BESIX has built a strong global presence and is active in 25 countries across 5 continents. A typical example is the Middle East, where BESIX has built a strong portfolio the past 50 years (including high-rise buildings, port infrastructure, waste water treatment plants, waste-to-energy facilities, etc.).

Recently, BESIX has entered the hydrogen sector. BESIX provides integrated solutions with agnostic technologies for the production, transportation, distribution and storage of hydrogen.

The mission of BESIX is to thrive as a sustainable and highly integrated contractor, offering its customers in the various markets in which it operates pioneering value-added solutions and excelling in delivery through the full capabilities of the BESIX Group and a trusted partnership. The vision is to excel in creating sustainable solutions for a better world.

Our link with hydrogen

- BESIX provides integrated solutions for the production, transportation, distribution and storage of hydrogen.
- BESIX promotes the usage of sustainable alternatives (such as hydrogen) on the BESIX worksites.



○Research & Training ○Production ○Transport, dist & storage ○Technology ●Engineering & integration ○Application ●End User

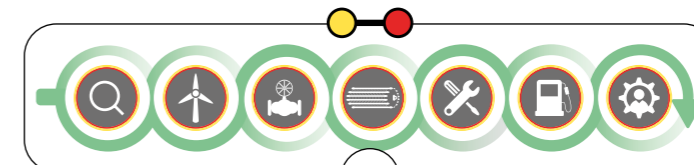



BIP-ELNEO
 www.bipelneo.com
 Tony Lippens
 tony.lippens@elneo.com

Our activities

BIP Elneo is a company where technical assistance and service are key. We offer you a complete solution for your questions / problems concerning instrumentation in connection with your tubing network, valves, protection boxes, pressure regulators as well as pressure measurements, level transmitters and flow measurements.

A team of experienced employees is always ready to give you expert advice by phone or on site to work out a suitable proposal. BIP Elneo can guarantee fast delivery from its extensive stock and many partners. We have also been active for many years in the hydrogen sector where we already work together with many members of «waterstofnet» for their applications. We have solutions over 1000 bars and also have the EC-79 certification.

Do not hesitate to contact us to discuss your application. <https://bipelneo.com/waterstof>

Our link with hydrogen

- We offer instrumentation (valves, fittings, pressure regulators and tubing) for hydrogen application.

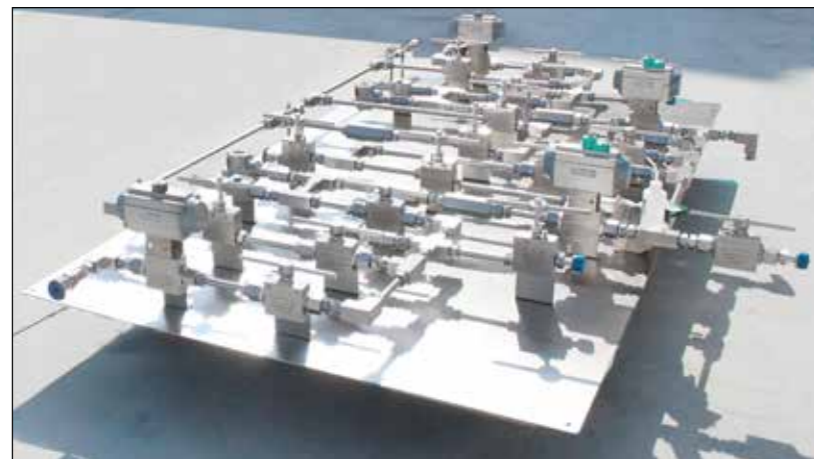

○Research & Training ○Production ○Transport, dist & storage ○Technology ●Engineering & integration ●Application ○End User

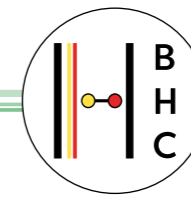
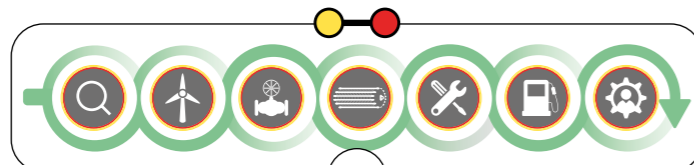

B-SENS
 www.b-sens.be
 Corentin Guyot
 corentin.guyot@b-sens.be

Our activities

B-SENS is a spin-off company of the University of Mons, launched in 2016. Its core business lies in the design and development of advanced sensing solutions based on the optical fiber technology.

B-SENS provides multipoint solutions for (high) temperature, strain and gas sensing. These solutions are optimized for use in harsh industrial environments and bring their unique assets such as easy integration, remote monitoring of hundreds of sensing points with a single device, high temperature resistance, electro-magnetic interference immunity, long-haul measurements and possible use in ATEX environments. In particular, B-SENS holds a patent on hydrogen leak detection based on this technology.

B-SENS solutions are custom made depending on customer specifications, principally for temperature mapping around industrial ovens and processes and for structural health monitoring.

Our link with hydrogen

- B-SENS develops H2 leak sensors based on the optical fiber technology and is therefore interested in applications (production sites, storage, transport, ...) where such sensors can be deployed and bring their decisive advantages compared to other technologies.



●Research & Training ●Production ○Transport, dist & storage ●Technology ●Engineering & integration ○Application ○End User

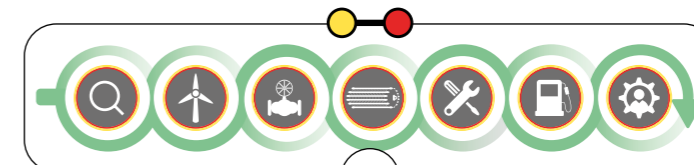



Borit NV
 www.borit.be
 Gert Nelissen
 gert.nelissen@borit.be

Our activities

Headquartered in Belgium close to Antwerp and employing about 30 FTEs, Borit was founded in 2010 and has developed into a one-stop-shop supplier of metal bipolar plates and assemblies addressing all relevant fuel cell and electrolyser technologies.

Borit operates a highly automated and digitized production facility providing a state-of-the-art manufacturing platform for small and medium series with a total production capacity of up to millions of parts per year. The leased facility includes 500m² offices and 3,500m² for manufacturing and warehousing. Its proprietary hydroforming technology ("HydrogateTM") and unique laser cutting and laser welding capabilities enable a swift, competitive and quality-assured process ranging from design to production.

Borit's manufacturing capabilities are engineered to scale up to high volume series production. Borit serves a strong and diverse international customer portfolio of more than 20 active customers, consisting of OEMs, Tier 1 suppliers, fuel cell and electrolyser technology companies active in automotive as well as in non-automotive segments.

Our link with hydrogen

- Borit is one of the worldwide leading independent manufacturers of metal bipolar plates for fuel cells and electrolysers.

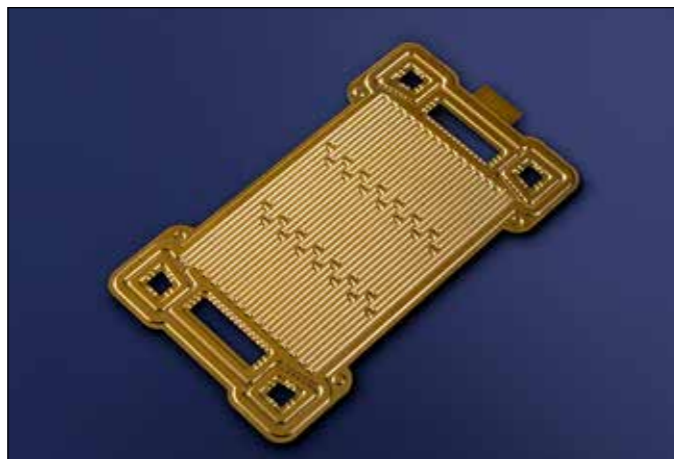

○Research & Training ○Production ○Transport, dist & storage ●Technology ○Engineering & integration ○Application ○End User

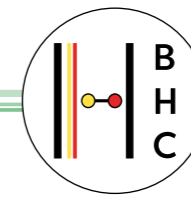
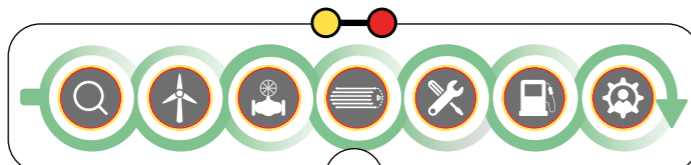

Bosal Energy
 https://www.bosal.com/en/energy
 Ted Straten
 ted.straten@bosal.com

Our activities

Our possible contributions: High temperature, high performance heat exchanger systems for next generation of fuel cells and electrolysers:

- Protective coating
- Catalytic coatings
- Development of hot balance of plant (BoP) for SOFC and SOEC • Hot box components' integration (e.g. reformers, oxidizers, electric heaters, insulation)
- Manufacturing process scale-up

Our technical expertise

- 25 years experience in development of high performance heat exchangers
- In-house manufacturing of heat exchangers prototypes, other BoP components, and Hotbox integration
- Facilities for performance & endurance testing of (catalytic) high-temperature heat exchangers and other hot BOP components
- Material science/engineering expertise
- Simulation capabilities including FEM, CFD and 1D system modeling
- Long automotive production and supply chain management experience

Our link with hydrogen

- Bosal is the worldwide leading company for high temperature, high efficiency and compact Heat Exchangers, required for the development of solid oxide fuel cells and electrolyser cells to produce and use hydrogen

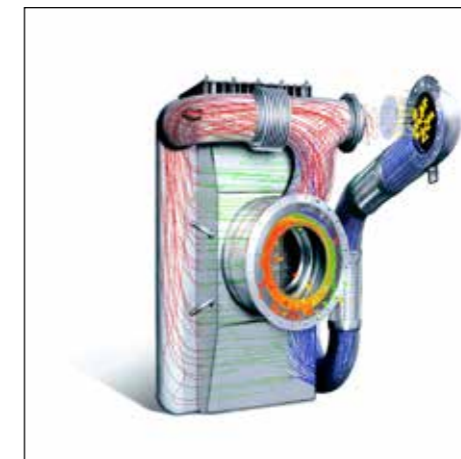

○Research & Training ○Production ○Transport, dist & storage ●Technology ○Engineering & integration ○Application ○End User

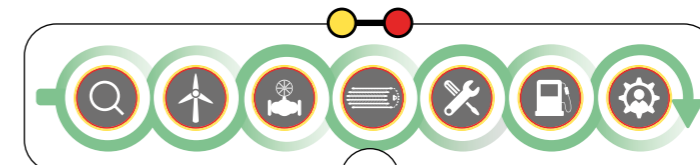



Bosch Thermotechnology nv
 www.bosch-homecomfort.be
 Walter Van Dael
 walter.vandael@be.bosch.com

Our activities

Bosch Home Comfort is a leading supplier in the HVAC market in Europe.

We are on our way for the carbon neutral energy world of tomorrow. We consider Hydrogen as one of the possibilities to support the energy transition for heating. These developments strongly depend on the availability of affordable and green Hydrogen.

Today, all our gas fired boilers are ready to work with a mix of up to 20% H2 and gas.

We have pilots in several countries with 100% hydrogen boilers in residential homes. In Brussels, at the site of Sibelga we have a demo with a 100% hydrogen boiler in a hybrid set up with a heat pump.

For larger industrial boilers, eg. in the process industry, we already have 100% hydrogen boilers available in portfolio.

Our link with hydrogen

- We are on our way for the carbon neutral energy world of tomorrow. We consider Hydrogen as one of the possibilities to support the energy transition for heating.



○Research & Training ○Production ○Transport, dist & storage ○Technology ○Engineering & integration ●Application ○End User

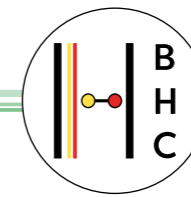
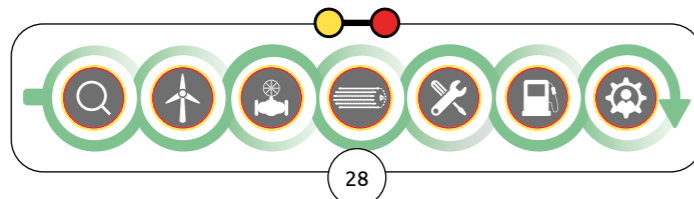

Brussels Airport Company
 www.brusselsairport.be
 Els Heyvaert
 els.heyvaert@brusselsairport.be

Our activities

Brussels Airport Company is the operator of Belgium's national airport. Brussels Airport is one of the main centres of economic growth in Belgium. As an airport in the heart of Europe, Brussels Airport is the ideal gateway to Brussels, Belgium and the rest of the world. In 2022, the airport welcomed nearly 19 million passengers. The airport also has significant cargo activity with 776,000 tonnes of cargo transported in 2022.

Brussels Airport caters to the specific needs of business and leisure travellers on both intra-European and long-haul flights. By 2023, it links Belgium directly to 200 destinations worldwide, offered by 70 airlines.

The airport also offers a leading cargo platform, specializing in the transport of pharmaceuticals, perishables, e-commerce and live animals. Brussels Airport is the leading pharmaceutical hub in Europe with the largest area of temperature-controlled warehouses.

Our link with hydrogen

- The aviation sector as a whole looks at options to decarbonize. Hydrogen is one of the technologies that will have a role to play in this. As an airport, we are preparing to provide the necessary infrastructure to make this possible.



○Research & Training ○Production ○Transport, dist & storage ○Technology ●Engineering & integration ○Application ●End User

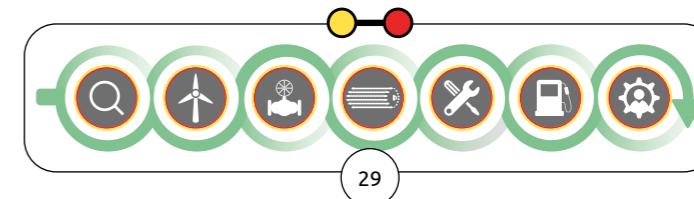



C-energy
<https://c-energy.be/en>
 Niko Bonnyns
 niko.bonnyns@c-energy.be

Our activities

C-energy focuses on energy management and «energy as a service»; and uses various technologies to provide this service; all technologies proposed are sustainable and aimed at decarbonising the energy landscape.

Together with customers, C-energy analyses their entire energy needs. Based on the analysis, the best solutions are selected to reduce the customer's energy costs and carbon footprint.

Hydrogen is an important part of the solutions proposed by C-energy. C-energy and the Cordeel Group already have experience in using hydrogen for mobility purposes, with a fleet of four hydrogen-powered pool cars and an on-site refuelling station at its headquarters in Temse. This facility will soon be expanded with its own electrolyzer.

Our link with hydrogen

- C-energy wants to be ready to integrate hydrogen into the energy solutions of the future.



○Research & Training ●Production ●Transport, dist & storage ○Technology ●Engineering & integration ●Application ○End User

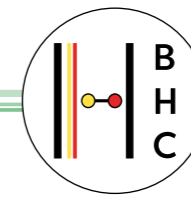
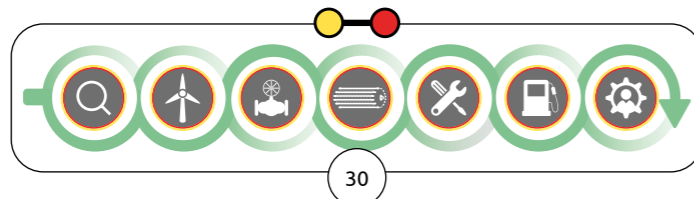

Callens
www.callens.eu
 Kris Stappers
 kris.stappers@callens.eu

Our activities

Callens is a Belgian family firm founded in 1966. In just over half a century we have grown into a much sought-after heating and air technology partner for the process engineering industry. Supplying a quality that is top-notch, on schedule, backed by an energetic service organisation that is unique in our industry, is very much part of our DNA and allows us to provide our customers with what they expect from us: speed, reliability and certainty.

Callens invests in trailblazing high-tech systems, with a focus on the economic and environmental interest. Our range of industrial boilers is constantly evolving. Just like the technologies, the energy market and your industrial needs. EcologiCal is the name under which we strive for smarter heat energy for all: industrial companies, both large and small. With the right alternative fuel and additional technologies, we lower your CO2 emissions and your energy bill. In both the short and long term. Solutions are available for all. Our heating technology currently consists of hydrogen-powered boilers, electric boilers, hybrid boilers, electrode boilers, biogas powered boilers, waste gas boilers, natural gas boilers and a wide range of energy recovery systems.

Our link with hydrogen

- We use hydrogen as an energy carrier to help companies with their sustainable goals like reducing CO2 emissions.



○Research & Training ○Production ○Transport, dist & storage ○Technology ●Engineering & integration ●Application ○End User

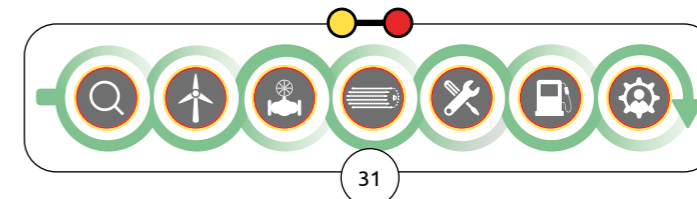



Capgemini Invent
www.capgemini.com/about-us/who-we-are/our-brands/capgemini-invent/
 Pieter De Cocker
pieter.de.cocker@capgemini.com

Our activities

Capgemini Invent is the digital innovation and transformation consulting branch of Capgemini. By leveraging the extended experiences and competences of the entire group, Invent offers a range of services to help clients transform their businesses and stay ahead in the digital age. These include data & advanced analytics, supply chain transformation, smart plant and connected products & services to drive transformation and innovation across sectors, from design and engineering to operations and maintenance.

By 2030, in addition to putting sustainability at the core of its activities to become climate neutral, Capgemini aims to maximize its impact by helping its clients save 10 million tons of CO2e. To achieve this, technology trends in industry and energy transition are closely monitored, allowing Capgemini Invent to provide expertise and services related to hydrogen, including supporting clients in developing hydrogen strategies, business models and implementation plans, as well as conducting research on its potential applications across the value chain.

Capgemini Invent Belgium gathers a team of 150 experts focused on sectors such as Energy, Chemicals, Pharma & Life science, Mobility, Telco & Finance

Our link with hydrogen

- By leveraging our extensive experience & competencies across the group, Capgemini is uniquely positioned to provide end-to-end portfolio innovation, consulting, design, engineering, and operation services and play a key role in accelerating the energy transition, together with our strategic partners & clients.



○Research & Training ○Production ○Transport, dist & storage ●Technology ●Engineering & integration ○Application ○End User

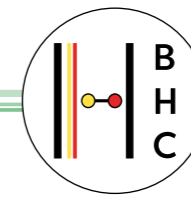
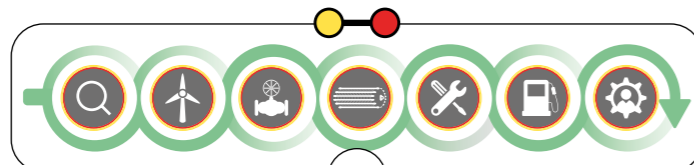

Cenaero
www.cenaero.be
 Cécile Goffaux
cecile.goffaux@cenaero.be

Our activities

Cenaero is a private non-profit applied research center & provides to companies involved in a technology innovation process numerical simulation methods and tools to invent and design more competitive products. Cenaero provides expertise and engineering services for high performance composites, thermo-fluid processes and systems modeling, optimization and uncertainty quantification, multidisciplinary topology optimization, metallic manufacturing processes modeling, high resolution computational fluid dynamics, hypersonic flows and ablative materials, turbomachinery design, and high performance computing.

Examples of value brought by Cenaero for H2 include:

- Production process optimization (reforming, electrolysis, etc) through multi-physics virtual prototypes
- Storage & transport technologies including composite tank optimization and thermal management and design & lifetime of critical components (coatings, valves)
- Conversion- Engine & fuel cell design
- Thermal management (2-phase flow technologies)
- Applications in H2-to-building with energy management systems & best energy mix Cenaero operates a high-performance computing infrastructure for fundamental, applied and industrial research.

Our link with hydrogen

- Numerical simulation and artificial intelligence for production, transportation & storage of Hydrogen from different sources and in it's different forms.

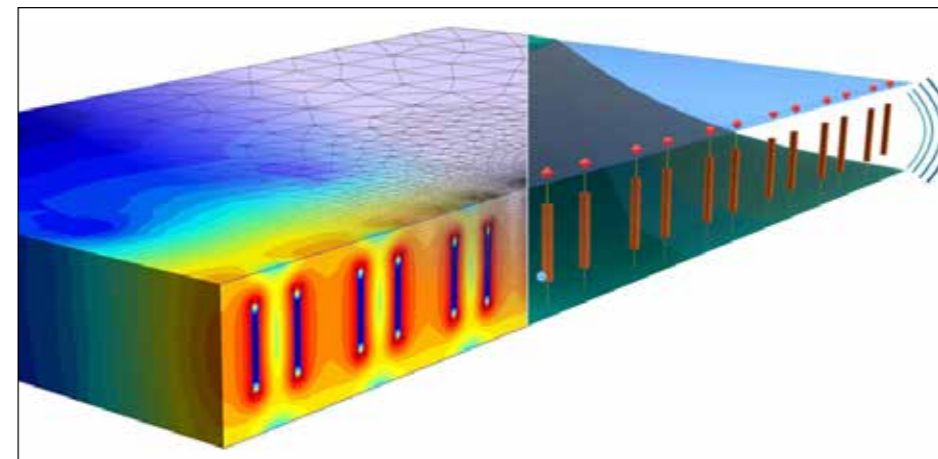

●Research & Training ○Production ○Transport, dist & storage ○Technology ●Engineering & integration ○Application ○End User

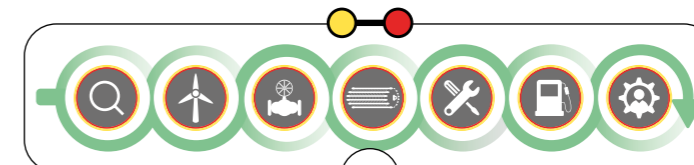



centrica

Centrica Energy
www.centrica.com
Guillaume Chaumont
guillaume.chaumont@centrica.com

Our activities

Centrica Energy is a leading European energy trader, delivering energy optimisation and enabling flexibility for your power generation, consumption, and storage assets. We'll secure returns on your assets, whilst you contribute to grid balancing and Belgian security of supply in a sustainable way.

- Industrial Power Flexibility - With 10-years of experience trading and optimising flexible assets in European wholesale and balancing markets, we offer industrial customers access to the most advanced cross-European virtual power plant, counting over 4GW of aggregated flexible assets including CHPs, industrial processes, and renewable assets.
- Battery Energy Storage Systems - Maximising returns for asset owners, we deliver multi-market arbitrage optimisation on wholesale and ancillary services with a proven track record. We'll monitor your asset optimisation strategy and markets round-the-clock, supported by our proprietary software, algorithms, and artificial intelligence.
- Power-to-X Optimisation - Acting as your trade floor, Centrica provides market access for your electrolyser and offerings on green RFNBO compliant power purchase agreements, green certificates, and risk management.

Our link with hydrogen

- Acting as your trade floor, Centrica provides market access for your electrolyser and offerings on green RFNBO compliant power purchase agreements, green certificates, and risk management.



○Research & Training ●Production ○Transport, dist & storage ○Technology ●Engineering & integration ○Application ○End User

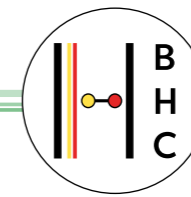
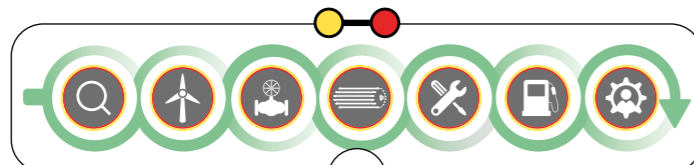

Certech
R&D partner in chemistry

Certech
https://www.certech.be/
François Collignon
info@certech.be

The research & development strategy of Certech is based on the synergies of three major themes, namely: environment, polymer materials technology, chemistry & industrial processes supported by an analytical & technological services platform.

Certech contributes to research and innovation activities addressing environmentally friendly technologies and allowing to support a sustainable economic development. These activities integrate the following topics:

- Integration at a local level of mixed renewable electricity sourcing (for domestic or industrial exploitations) through the production of hydrogen or via storage in batteries.
- Reduction of the hydrogen storage costs via solid storage in porous materials, namely the Metal-Organic Frameworks (MOF). These MOF must be relevant from technical and regulatory aspects. The porous solids are developed in specific reactors, to increase their production while reducing the costs and environmental impact of the syntheses.

Our link with hydrogen

- Certech guides the energy sector since the beginning of eco-efficient product. Our society currently works to improve the storage of Hydrogen.



●Research & Training ●Production ●Transport, dist & storage ●Technology ●Engineering & integration ●Application ○End User

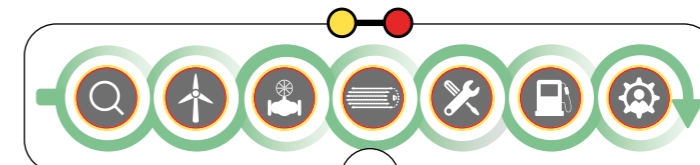



CGI
www.cgi.com
Kai Polak
kai.polak@cgi.com

Our activities

CGI is an IT and business consulting services company. We deliver consultancy, systems integration services in addition to managed IT and business process services. Our solutions are instrumental in guiding our customers on their digitalization journeys. We are closely aligned with local markets, such as Belgium, while having a global reach.

Across the world, ecosystem-driven pilot projects are underway to accelerate the transition to a hydrogen-driven economy. CGI AgileDX-Hydrogen is a data exchange platform built to support effective collaboration within hydrogen ecosystems. It provides a centralized view of data and processes, promotes full transparency and auditability, and enables seamless internal and external communication to help make insight-led business decisions. The platform's valuable data insights can support new funding for ongoing projects, launch new initiatives, and help introduce progressive legislation.

CGI AgileDX-Hydrogen builds a virtual hydrogen ecosystem so all market participants can access relevant data through easily customized dashboards. It is a configurable, modular, integrated and scalable platform that enables seamless data exchange and communication between all stakeholders.

Our link with hydrogen

- Our vision is that digitalization is an important enabler for the scale-up of the hydrogen economy. Our AgileDX-Hydrogen solution is designed to digitalize the hydrogen value chain, starting from production, right through to consumption.



○Research & Training ○Production ○Transport, dist & storage ○Technology ○Engineering & integration ○Application ○End User

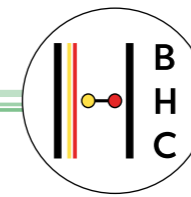
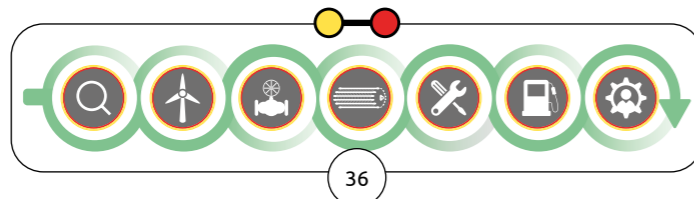

CHEVRON PHILLIPS CHEMICAL
www.cpchem.com
Jasper Smets
smetsj@cpchem.com

Our activities

Chevron Phillips Chemical is one of the world's top producers of olefins and polyolefins and a leading supplier of aromatics, alpha olefins, styrenics, specialty chemicals, plastic piping and polymer resins. CPChem produces the building blocks for more than 70,000 products that help improve the lives of humankind worldwide. Sustainability is embedded in our company strategy and across our organization to address our impacts as we advance toward a more sustainable future.

With approximately 5,000 employees worldwide, CPChem and its affiliates own nearly \$18 billion in assets, including 31 manufacturing and research facilities in six countries. Chevron Phillips Chemical is owned 50 percent by Chevron U.S.A. Inc. (Chevron), an indirect wholly owned subsidiary of Chevron Corporation, and 50 percent by Phillips 66 Company (P66Co), a wholly owned subsidiary of Phillips 66.

In Belgium, Chevron Phillips Chemicals International NV, a subsidiary of Chevron Phillips Chemical Company LLC, is headquartered in Diegem and coordinates the sales and marketing activities for the EMEA region. It also owns and operates a plant in Tessenderlo which produces organic sulfur compounds and a plant for the production of polyalphaolefins.

Our link with hydrogen

- CPChem is using hydrogen as a chemical feedstock and is exploring the use of hydrogen as an energy carrier to further reduce its environmental footprint.



○Research & Training ○Production ○Transport, dist & storage ○Technology ○Engineering & integration ○Application ○End User

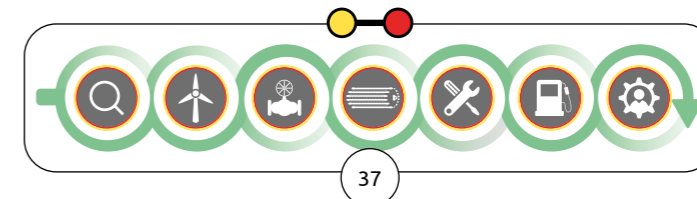



CLIMACT

CLIMACT
www.climact.com
Benoît Martin
bm@climact.com

Our activities

We help companies and public authorities on understandings the energy vectors and sectors, in the context of the climate transition. We look at both supply and demand of H2 and the technical and economic current and future developments, in Belgium and in Europe. We mobilize recognized complementary expertises to address best our clients requests.

Our link with hydrogen

- We look at both supply and demand of H2 and the technical and economic current and future developments, in Belgium and in Europe.

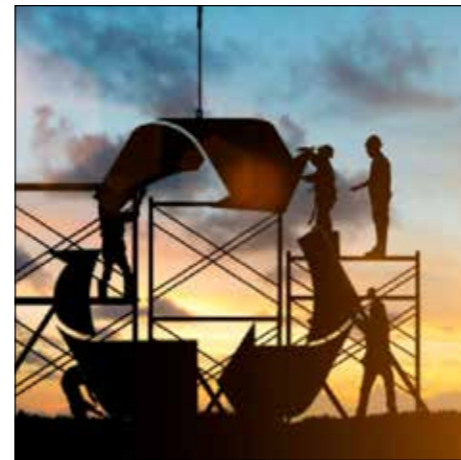
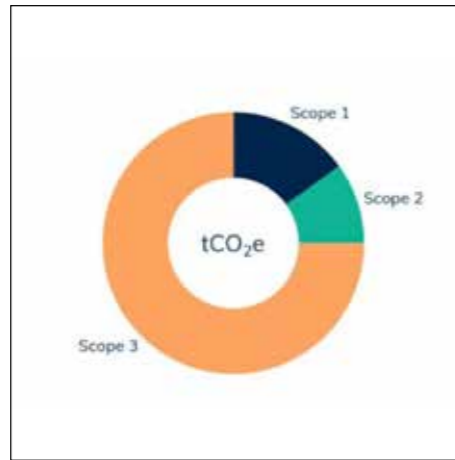

○Research & Training ○Production ○Transport, dist & storage ○Technology ○Engineering & integration ○Application ○End User

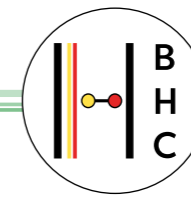
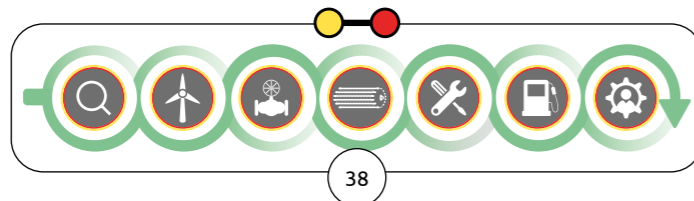

CMB.TECH

CMB.TECH
www.cmb.tech
enquiries@cmb.tech
enquiries@cmb.tech

Our activities

CMB.TECH is a shipping and cleantech company that develops, builds, owns and operates large marine and industrial applications that can run on hydrogen or ammonia. CMB.TECH also offers hydrogen and ammonia fuel to its customers, either through own production or third party producers. Our marine division features a future-proof fleet. CMB.TECH Industry is a leading provider of scalable dual fuel platforms for industrial applications. Our proven combustion technology allows us to develop heavy-duty engines that run on hydrogen, while providing flexibility, robustness and cost-effectiveness.

Through smart partnerships such as MAN, Volvo Penta, Ford and BeHydro we can offer hydrogen-powered engines that are easy to deploy, operate and maintain in the field.

Several industrial applications such as hydrogen-powered trucks & port equipment are already operational in the field, and we are scaling up their deployment.

At our H2 Infra business unit, we integrate and operate the essential technology and infrastructure for the production and distribution of green hydrogen and ammonia.

With our projects in Namibia, we will be able to produce and supply green hydrogen and ammonia at an industrial scale.

Our link with hydrogen

- CMB.TECH's business model is to own/lease out or sell assets to customers looking for low/zero carbon solutions. CMB.TECH believes that hydrogen for small ships and ammonia for large ships can play an important role to decarbonize the shipping industry. Our hydrogen-powered vessels like Hydroville, Hydrocat, Hydrobingo & Hydrotug and our large ammonia-powered bulk carriers, container vessels and chemical tankers, are paving the way for a greener tomorrow.

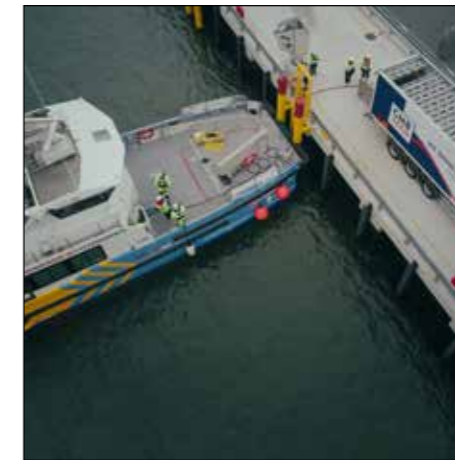
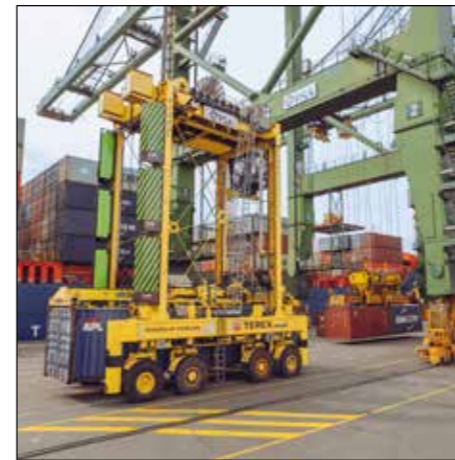

○Research & Training ○Production ○Transport, dist & storage ○Technology ○Engineering & integration ●Application ○End User

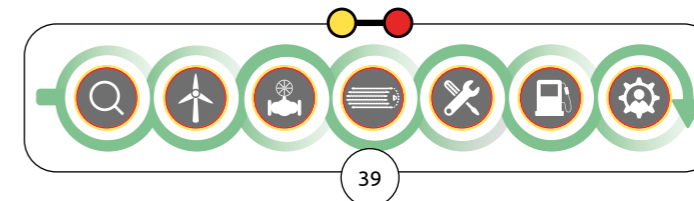



Colruyt Group
 www.colruytgroup.com
 Herman Annendyck
 herman.annendyck@colruytgroup.com

Our activities

Colruyt Group is best known for its retail activities with the Colruyt supermarkets in Belgium and France. However, Colruyt Group is also active in wholesale, export, technology, food production, automation, ... Colruyt Group is a family of companies and operates under brands such as Colruyt Laagste Prijzen, OKay, Bio-Planet, Dreambaby, Collect&Go, Spar, Bike Republic, Jims, Colruyt Prix Qualit , BONI

Colruyt Group has a major participation in the holding Virya Energy which is active in sustainable energy projects via the companies DATS24, EOLY, ... (see <https://www.virya-energy.com/>).

Colruyt Group is also implementing zero emission freight transport and based on green energy: please consult our ambitions and roadmap on our specific webpage via <https://www.colruytgroup.com/en/sustainable-entrepreneurship/initiatives/zero-emission-transport#2022>

Our link with hydrogen

- Colruyt Group has been pioneering in the field of hydrogen production via electrolysis and in the field of hydrogen tanking stations. In our distribution centers in Halle and Ollignies, several forklifts, FCEV cars and trucks are operated on hydrogen in real life operational conditions.



Research & Training Production Transport, dist & storage Technology Engineering & integration Application End User

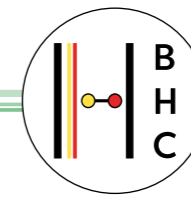
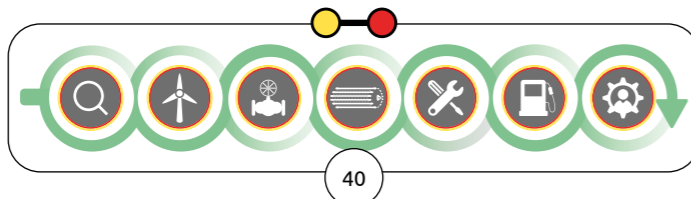

COVRESS
 www.covess.com
 Tony Vanswijgenhoven
 tony@covess.com

Our activities

Covess was born in 2000 and developed a revolutionary process using 100% recyclable thermoplastic materials with endless glass and/or carbon fibers. In the early years tanks for the use of cold and hot water were manufactured and sold worldwide. Nevertheless, the strategy was, and still is to sell licenses for different applications over several geographic areas to produce locally.

As from 2014, on behalf of one of the biggest gas manufacturers/distributors of the world, Covess started to develop a type 5 thermoplastic cylinder especially for transport/storage of H2. Today our R&D tanks/cylinders are in the final stage and final tests are running with product results that are 20-30% lighter than the market offers today. The vacuum resistance helps as well.

Early next year Covess starts certification to multiple standards. In the meantime, worldwide negotiations have started up to license companies with our technology to produce locally cylinders for all kind of gases but especially H2.

Our link with hydrogen

- Covess is the first manufacturer in the world of a 100% thermoplastic and thus 100% recyclable tank for hydrogen transport and/or storage. Covess' tanks are 20% lighter resulting in a significant higher payload for transport companies.



Research & Training Production Transport, dist & storage Technology Engineering & integration Application End User

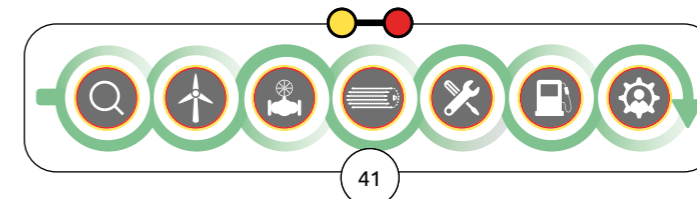

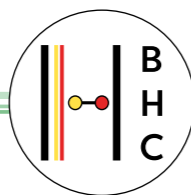

CRM
<https://www.crmgroup.be/>
 Catherine Archambeau
 catherine.archambeau@crmgroup.be

Our activities

The CRM Group is a research center dedicated to metallic materials for 75 years developing innovative products, processes and solutions likely to create value among its industrial partners (large, medium and small companies), in different application sectors such as the steel industry, manufacturing industry, energy, automotive, aeronautics and defense. The services offered by the CRM Group range from incremental research to breakthrough R&D projects, to technical assistance, with the objective of bridging the gap between science and the market and supporting companies, from the laboratory to their applications.

CRM Group has set up a Strategic Platform to support energy transition by innovation bringing together its activities in the field of the development of renewable energies, storage, hydrogen, decarbonization of industrial processes, CO2 capture and alternative fuels. This innovation is fed by strong expertises in applied electrochemistry, material synthesis and characterization, innovative solutions and device development, pilot and prototypes for various applications, sectors and industrial processes.

CRM Group is also member of e-WallonHY Strategic Innovation Initiative for wallon Hydrogen innovation ecosystem.

Our link with hydrogen

- CRM Group carries out research activities across the entire hydrogen sector: production of hydrogen by electrolysis, study of metal/hydrogen interactions, development of metal protection barrier solutions and use of hydrogen in industrial processes and for fuel cells.

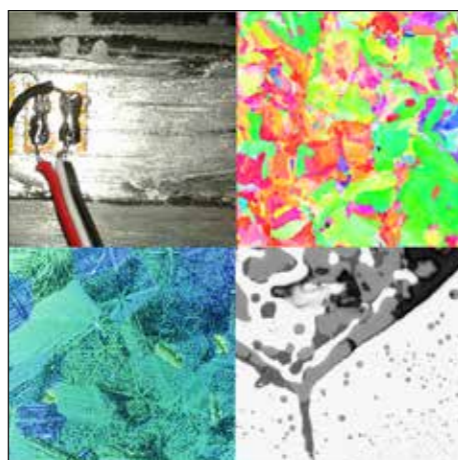

Research & Training
 Production
 Transport, dist & storage
 Technology
 Engineering & integration
 Application
 End User

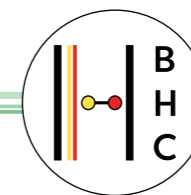
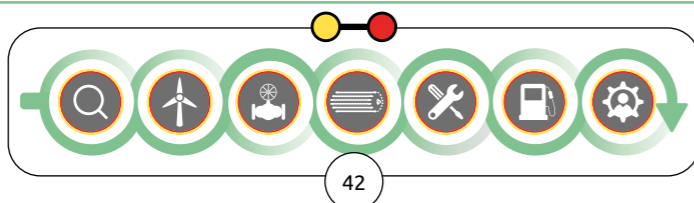

DEME HYPOR Energy
www.deme-group.com
 Jean-Baptiste De Cuyper
 jbd@deme-group.com

Our activities

DEME HYPOR Energy is a leading developer of fully integrated, utility-scale green hydrogen projects, including the generation of renewable energy, production of green hydrogen and downstream conversion, with a vision to provide end-user markets with competitive green molecules, under the HYPOR® concept.

Our link with hydrogen

- As a project developer, DEME HYPOR Energy is capable of integrating the full hydrogen value chain, from generation of renewable energy to water electrolysis and potential downstream conversion steps to e.g. green ammonia.



Research & Training
 Production
 Transport, dist & storage
 Technology
 Engineering & integration
 Application
 End User

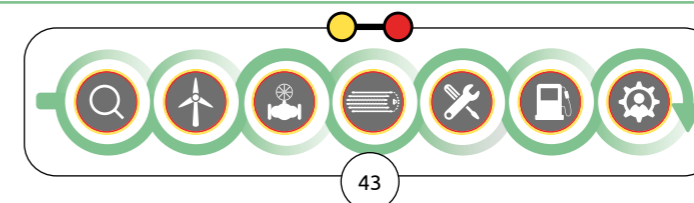



District Cleantech
<https://www.districtcleantech.be/>
 Marc Van Den Neste
 marc.vandenneste@districtcleantech.be

Our activities

District Cleantech is an economic hub accelerating and supporting low carbon transition of companies in Charleroi. By 2030, the goal is to establish a thriving cleantech ecosystem by converting a 34-hectare wasteland into a business park that welcomes cleantech companies and pioneers. Amongst the cleantech themes covered, one is dedicated to Hydrogen. There will be a Belgian center of expertise and testing, the VKHyLab, dedicated to H2 technologies. The ambition is unprecedented in Belgium and Europe: an open testing center, coordinated and operated by the von Karman Institute, offering state-of-the-art equipment and unique infrastructure to users who can handle significant volumes of hydrogen safely. With partners like AGC, MateriaNova, BeBlue, CRM, ULB, these experimental facilities meet the needs of a variety of applications related to the hydrogen value chain, such as : low-cost H2 production, H2 combustion (to decarbonize heavy industry), green mobility (road, air and maritime transport), materials engineering, safety and training. Other projects contribute to the overall ecosystem: Columbus (CCU project involving Carmeuse, JC and Engie), a Direct Air Capture project in the pipeline and the production of green H2.

Our link with hydrogen

- The ecosystem District Cleantech will welcome an open testing center operated by the VKI and its partners on site (ULB, MateriaNova, AGC, BeBlue, CRM) allowing users to perform test with significant volumes of hydrogen safely. It will cover a variety of applications : low-cost hydrogen production, combustion, green mobility, material engineering and safety. Linked to the ecosystem, there will also be projects around Carbon Capture and Utilization, Direct Air Capture and individual industrial H2 projects.

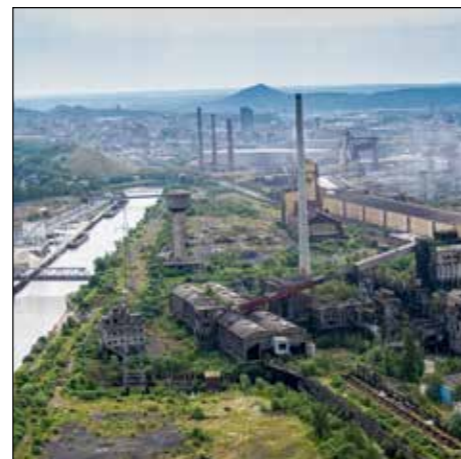

○Research & Training ●Production ●Transport, dist & storage ●Technology ●Engineering & integration ●Application ●End User

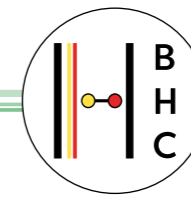
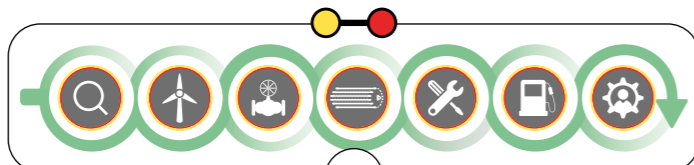

Eiffage Energy System
<https://eiffagebenelux.be/fr/>
 Rochdi Jeddaoui
 Rochdi.JEDDAOUI@eiffage.com

Our activities

Eiffage Énergie Systèmes designs, builds, operates and maintains electrical, industrial, climate and energy engineering systems and equipment with respect for people and the environment. Eiffage Énergie Systèmes offers a tailor-made offer for the industrial, infrastructure and networks, cities and regions and tertiary markets. Thanks to its dense network of agencies in more than 50 countries, Eiffage Énergie Systèmes builds a close relationship and responds as accurately as possible to the challenges of its customers. Its advanced expertise also allows it to offer innovative solutions with high added value. Eiffage Énergie Systèmes draws on the experience of nearly 30,000 employees and achieved a turnover of 5.3 billion euros in 2022.

Eiffage Énergie Systèmes has already participated in several projects in the field of Hydrogen in Belgium, the Netherlands, France and Spain. The services offered are diverse and use hydrogen to serve mobility and industry. In Belgium, Eiffage Énergie Systèmes has been active for more than 75 years and has around 1,100 employees.

Our link with hydrogen

- The group's desire is to further grow its activities in the field of hydrogen because we are convinced that this molecule is a key energy of the future.

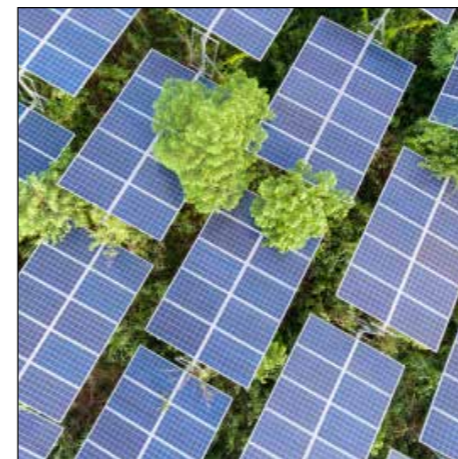

○Research & Training ●Production ●Transport, dist & storage ●Technology ●Engineering & integration ●Application ●End User

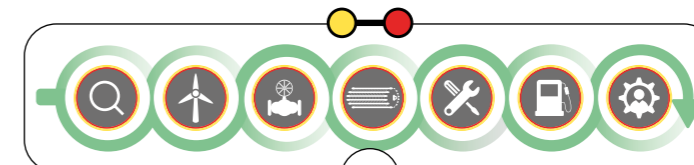



Eneria
 www.eneria.be
 Erwin Theys
 etheys@eneria.be

Our activities

Eneria is a subsidiary of Monnoyeur that specialises in power production and engine solutions. Eneria has developed renowned expertise and know-how in turnkey power solutions.

Eneria designs, installs and maintains these installations. Eneria can integrate a broad selection of products, such as diesel and gas gensets and UPS, engines for marine, industrial and oil and gas applications, photovoltaic panels, thermal solar panels, biomass boilers, hydrogen solutions and hybrid systems with storage.

As the Belgian distributor of the GEH2® EODev hydrogen genset our goal is to be seen as your preferred transformation partner to guide you and help you in your Transformation towards a carbon neutral economy in 2050.

With our business unit focusing on Decarbonisation and energy transition, we are expanding our range of products and services that answer energy issues that many companies are grappling with today.

The energy issues facing companies today are often a combination of 3 simple questions:
 As a company, how can I reduce my energy consumption? As a company, how can I reduce my energy costs? As a company, how can I reduce my carbon footprint?
 With an extensive team of product and energy experts, Eneria is ready to answer them.

Our link with hydrogen

- As the Belgian distributor of the GEH2® EODev hydrogen genset our goal is to be seen as your preferred transformation partner to guide you and help you in your transformation towards a carbon neutral economy in 2050.



○Research & Training ○Production ○Transport, dist & storage ●Technology ○Engineering & integration ○Application ○End User

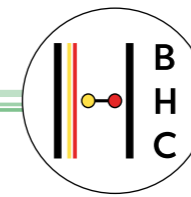
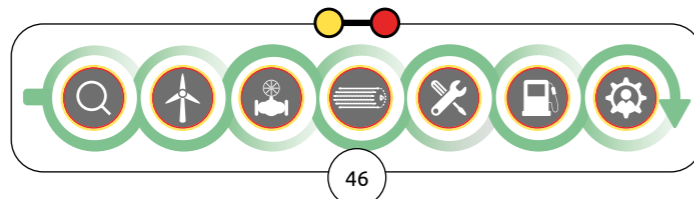

Engicon nv (Geldof)
 www.geldof.com
 Pieter Van Acker
 pieter.van.acker@geldof.com

Our activities

Geldof is an engineering fabricator/contractor of 'integrated steel solutions' for the storage, handling and processing of bulk solids, liquids and gasses.

Our company holds a strong reputation in the realization of storage tank projects and maintenance services, pressure vessels and dry bulk storage and handling installations. With years of experience within the energy sector, we are actively focusing on major energy transition projects.

Our link with hydrogen

- Geldof has built up extensive expertise in the cold and/or pressurised storage of ammonia (as a hydrogen carrier), hydrogen and CO2 and is also active in other fields of sustainable energy such as biofuels storage and solid biomass handling.



○Research & Training ○Production ○Transport, dist & storage ○Technology ●Engineering & integration ○Application ○End User

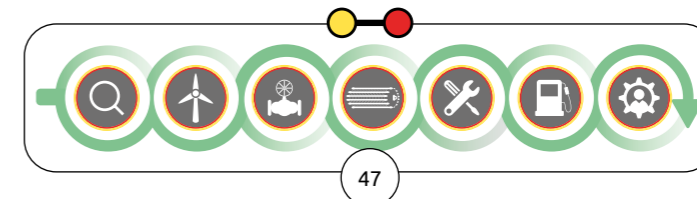



Engie
 www.engie.com
 Koen Vlaeminck
 koen.vlaeminck@engie.com

Our activities

ENGIE has positioned itself as a major player in renewable hydrogen and operates along the entire length of the hydrogen value chain – from production of renewable energies to end uses.

From research to marketing, ENGIE is involved in production through to end uses: strategy, design, engineering, building low-energy assets, digital platforms, operation, funding and performance obligation.

ENGIE's aim is to be a leader in the production of renewable hydrogen on a large scale. We are working in three main development areas: industrial uses, mobility and hydrogen as an energy vector, for which we are developing solutions, entering into partnerships and exploring various innovative technologies.

ENGIE also develops low-carbon hydrogen (bleu hydrogen) in Belgium as to kick-start the hydrogen (and CO2) value chain and to reach the 2030 and 2050 net zero carbon targets.

Our link with hydrogen

- Hydrogen is an essential component of the energy mix:
 - store renewable energy and make it available when renewables are not producing electricity
 - develop more sustainable forms of mobility - decarbonise industrial uses

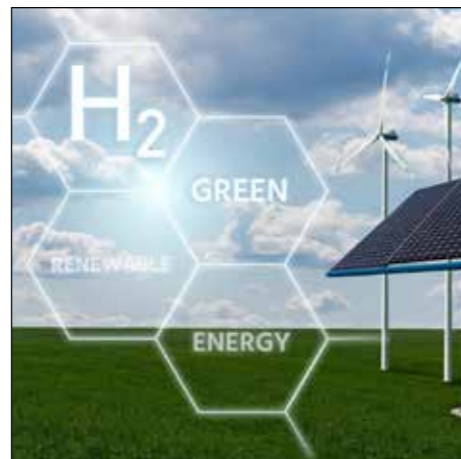

○Research & Training ●Production ●Transport, dist & storage ●Technology ●Engineering & integration ●Application ●End User

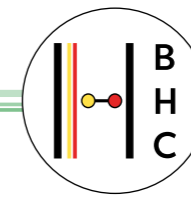
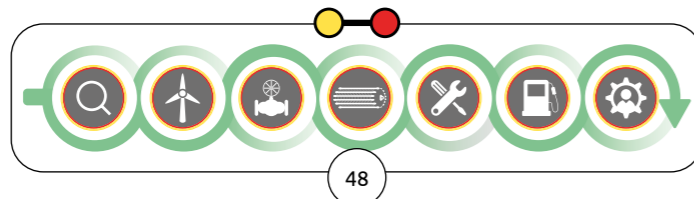

E-Trucks Europe
 https://e-truckseurope.com/
 Anna van Hulsel
 Annelies@e-truckseurope.com

Our activities

E-Trucks Europe develops, builds and supplies hydrogen-electric vehicles. In 2010, the company was founded and started building purely electric vehicles. Pretty soon, the range proved too limited. Pure electric is not a sufficient solution for heavy transport because of the required size and weight of the battery pack. Compressed hydrogen is an excellent energy carrier. This is why E-Trucks Europe is working with a hydrogen system as a range extender.

In all E-Trucks Europe vehicles, an electric motor, powered by a battery pack, is used to drive all energy-demanding systems. A fuel cell system powers the battery system while driving. The power is generated from hydrogen stored in tanks under 350 bar pressure and oxygen from outside air. Clean water is released as the only waste product.

After the first proof-of-concept in 2013, the technology has been further developed. E-Trucks Europe has delivered refuse vehicles in the Netherlands, Belgium and Germany. The first trucks for France are also ready for deployment. The European ambition of E-Trucks Europe has led to participation in several national and European projects together with other leaders in the hydrogen chain.

Our link with hydrogen

- E-Trucks Europe focuses on the sustainability of vehicles with energy-consuming bodies (such as refuse vehicles) using hydrogen as an energy carrier.



○Research & Training ○Production ○Transport, dist & storage ●Technology ●Engineering & integration ●Application ○End User

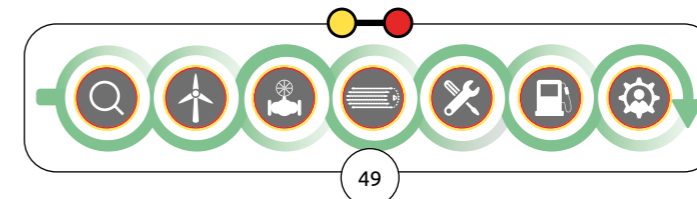



Eurosealings NV
<https://www.eurosealings.be/>
 Geert Van Kelst
 geert.vankelst@eurosealings.be

Our activities

Eurosealings: Pioneering High-Quality and Sustainable Sealing Solutions Eurosealings is a sealing manufacturer based in Belgium, specializing in delivering innovative and high-quality sealing solutions to industries worldwide.

Commitment to Quality and Sustainability At Eurosealings, quality is fundamental, ensuring the highest standards in producing metal O-rings, C-rings, spring-energized PTFE sealings, and custom sealing solutions. Our products meet stringent standards, ensuring reliability. We power our operations entirely through 100% solar energy, effectively reducing our carbon footprint. Advanced manufacturing processes for metal seals and PTFE seals minimize wastewater, emphasizing our commitment to sustainable practices.

Diverse Application Expertise Eurosealings offers customized solutions to various industries worldwide, including pharma, food & beverage, filtration systems, LNG, machinery, oil & gas, aerospace, laser technology, and green energy. We have the expertise to offer our sealing solutions to PEM & Alkaline Electrolysis, Transportation & Storage, hydrogen pipeline valves, liquid or gaseous hydrogen transport, underground storage wellheads/valves, cryogenic hydrogen liquefaction valves, and high-pressure storage tanks, hydrogen refueling stations - systems or hydrogen gas turbines

Building Long-Term Partnerships Eurosealings is dedicated to building long-term partnerships with our clients, ensuring their success through reliable, durable, and efficient sealing solutions. Please feel free to connect with our team of experienced professionals who are passionate about solving complex sealing challenges and driving innovation. Together, we can achieve remarkable advancements in sealing technology while promoting a sustainable future.

Our link with hydrogen

- Our interest in hydrogen lies in providing advanced sealing solutions that enhance the efficiency, safety, and reliability of hydrogen production and renewable energy technologies, driving the transition to a sustainable energy future

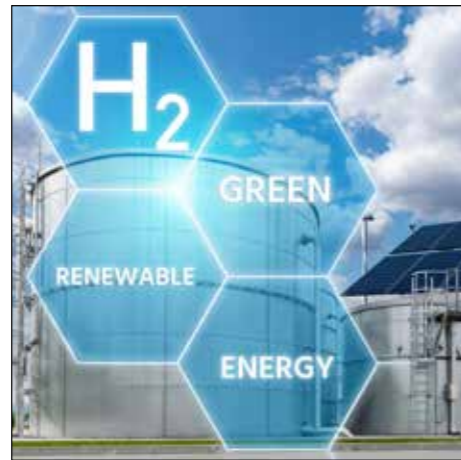

○Research & Training ○Production ○Transport, dist & storage ○Technology ○Engineering & integration ○Application ○End User

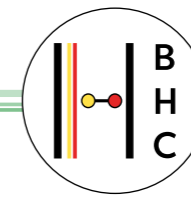
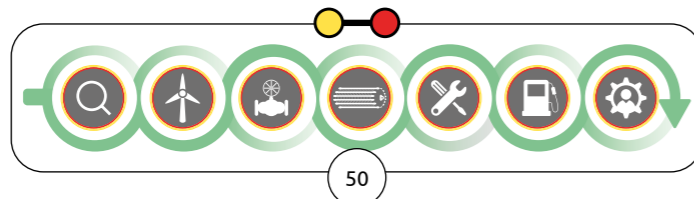

E. VAN WINGEN NV
www.vanwingen.be
 KOEN HAENTJENS
 koen.haentjens@vanwingen.be

Our activities

E. VAN WINGEN NV is based in Flanders, Belgium, and has a +50 year track record of power solutions engineering and manufacturing. EVW is specialized in energy solutions and control systems for a wide array of applications. Sustainable, green energy is paramount to EVW's design and development philosophy.

From its strong belief in corporate social responsibility and its innovative spirit EVW has been developing energy efficiency power generation products from the '90s, starting with natural gas and moving to biogas applications, to arrive at zero emission solutions now. Its H2 ICE CHP, already endurance tested for more than 4000 hrs.

Smart H2 Solution : ICE CHP running on H2 ensures that electric power at 0 g CO2, heat or cooling are always present in the autonomous microgrid, even when the sun is not shining or when there is no wind.

Thanks to our solution, the local grid will not take uncontrolled power from or inject it into the public grid. It will make a positive contribution to solving the problems of grid congestion and grid stability, supplying reactive power and contributing to the short circuit power on the grid.

Supporting the public power grid, it prevent black outs and helps to create a 100% green energy landscape.

Our link with hydrogen

- Our aim is to link energy flows like electricity , heat, cooling, mobility at 0 gram CO2 and 100% recycle.



○Research & Training ○Production ○Transport, dist & storage ○Technology ○Engineering & integration ○Application ○End User

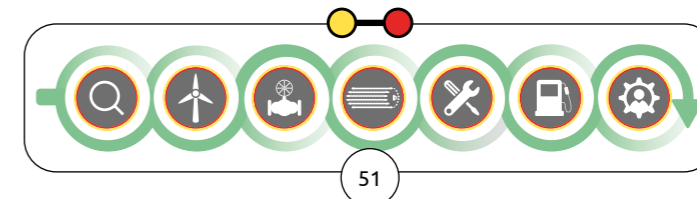



EXION
HYDROGEN

Exion Hydrogen
www.exionhydrogen.com
Guy Verkoeyen
guy.verkoeyen@exionhydrogen.com

Our activities

We build better electrolyzers.

«We» - Exion Hydrogen is an ambitious, privately-owned company in the electrolyzer business, and was founded in 2021 by ZE PAK S.A. and Cyfrowy Polsat S.A. Our headquarters and production plant are in Gdansk, Poland. The R&D and Business Development Center is based in Turnhout, Belgium.

«Build Better» - as in a complete new manufacturing plant specifically equipped to build electrolyzers, driven by a team with decades of experience integrating and constructing industrial equipment.

Better Electrolyzers - as in a team of industry veterans and highly skilled engineers that were given the opportunity to start from a blank sheet of paper. Starting from all this profound knowledge and available experience we are designing and developing a new generation of more robust, reliable, and efficient water electrolyzers to ensure safe and affordable on-site hydrogen production

Our link with hydrogen

- Water electrolyzers are key for the production of Green Hydrogen thus supporting the fight against climate change. We build better electrolyzers.



○Research & Training ●Production ○Transport, dist & storage ●Technology ●Engineering & integration ○Application ○End User

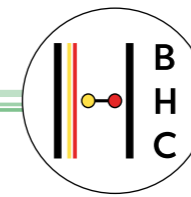
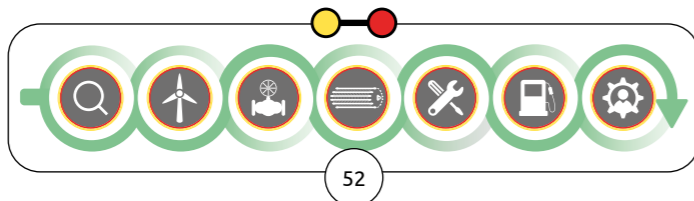

FESTO

Festo Belgium
www.festo.be
Rotsaert Marc
marc.rotsaert@festo.com

Our activities

Festo is a global player and an independent family-owned company with companies in about 60 countries. We supply automation technology and technical training solutions for over 35 industries.

Festo has made a strong commitment to investing in hydrogen. We put our experience and expertise into it.

Our core business is the automation of your skids or installations. We offer a complete automation pyramid, from touch screens to automated ball valves dedicated to hydrogen, through the RIO's, valve terminals and air filter units. Of course with ATEX and SIL certifications.

And if this control equipment has to be integrated into a control panel, we also take care of it. Naturally, ATEX certified.

Whether it's an electrolyser, a compressor station, a refuelling station, a PSA unit, LOHC storage... let's discuss the automation concept for your installation.

With us, efficiency and functional safety go hand in hand. Improve the performance of your installation using our automation solutions. We offer a broad portfolio of SIL-certified components that are approved for use in potentially explosive atmospheres.

Visit us on www.festo.com/hydrogen and let's talk about automation concept of your installation.

Our link with hydrogen

- We like to talk about automation and safety concept around the machines of our customers or in front of their PnID

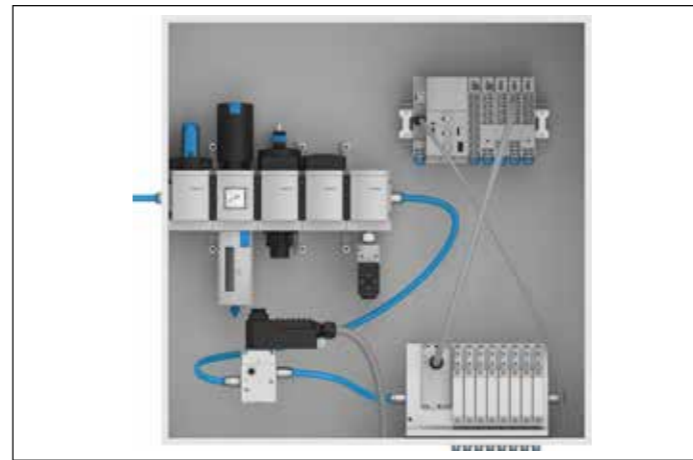

○Research & Training ○Production ○Transport, dist & storage ○Technology ●Engineering & integration ●Application ○End User

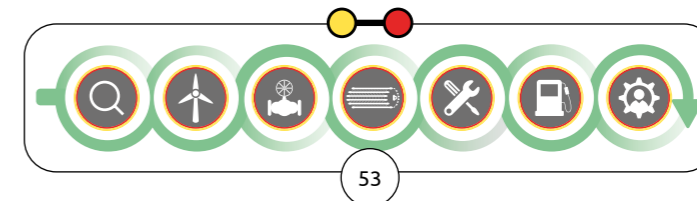



Fluvius
<https://www.fluvius.be>
 Hilde Vanbelle
hilde.vanbelle@fluvius.be

Our activities

Fluvius System Operator cv is the independent company that is responsible for building, managing and maintaining the distribution grids for electricity and natural gas in all 300 Flemish municipalities.

Fluvius is also responsible for building, managing and maintaining the sewerage system in 85 Flemish municipalities and for building district heating grids.

Fluvius also manages the public lighting in all 300 Flemish municipalities and support Flemish local authorities in their drive towards more energy efficiency and obtaining the climate objectives. Fluvius has a major role in achieving the energy transition.

Our link with hydrogen

- Fluvius operates a natural gas grid of 58.000 kms, and has an excellent expertise in operating gas grids. This gas grid, or parts of it, could be repurposed for distribution of hydrogen.



Research & Training Production Transport, dist & storage Technology Engineering & integration Application End User

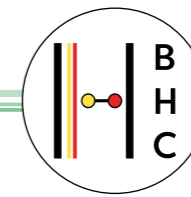
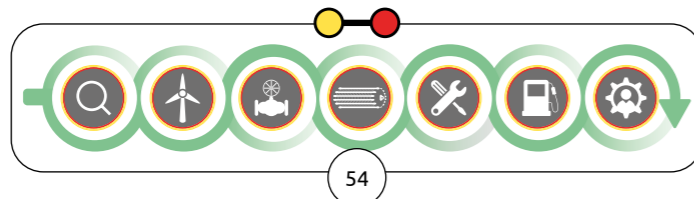

Fluxys
www.fluxys.com
 Michel Van den Brande
michel.vandenbrande@fluxys.com

Our activities

Since Fluxys was founded in 1929, we have been pursuing a deeply rooted purpose: providing people, businesses and society with energy. We bring energy where it is needed.

With nearly a century of experience in gas transmission and transport, we are now in the process of building a multi-molecule hub for a carbon-neutral future.

We want to be the essential infrastructure partner for accelerating the transition from fossil to renewable energy. We are committed to continue building a cleaner energy future for generations to come. People, industry and societies all need energy to thrive and progress. We meet that need. With our infrastructure we put energy in motion – in Europe and Latin America.

We transport natural gas and we are ready to transport hydrogen, biomethane and any other low-carbon energy carriers, as well as CO₂, all in an ongoing effort to support carbon capture, reuse and storage.

On 26 April 2024, Fluxys hydrogen was appointed by the federal government as Belgium's hydrogen network operator, empowering us to further develop a hydrogen network and drive the energy transition forward.

Our link with hydrogen

- Through our extensive and reliable network of pipelines, we will bring hydrogen (H₂) to industrial companies.
- We want to offer the first hydrogen transport capacity by 2026, which is how we will help build a climate-neutral economy and society. This is the first step of establishing connections between industrial zones as well as implementing connections with neighbouring countries.



Research & Training Production Transport, dist & storage Technology Engineering & integration Application End User

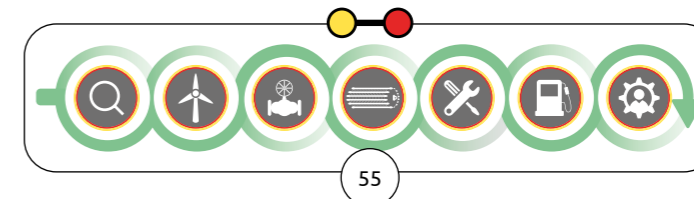



GDTech
<https://www.gdtech.eu/>
 Eros Gabellini
 eros.gabellini@gdtech.eu

Our activities

GDTech, headquartered in Liège, Belgium, is an engineering service company specialist in providing design, numerical modelling and simulation services to major players in aerospace, automotive and energy sectors. GDTech uses first-in-class software suites to help its customers reduce their time to market and enhance the quality of their products by decreasing the amount of physical prototypes and trial and errors in the design phase. Domains addressed include equipment and systems design, structural mechanics, fluid dynamics, multiphysics and systems modelling.

GDTech covers the entire H2 cycle, from grid to combustion, including production, storage, transportation and fuel cells:

- Multiphysics systems modeling (at production, distribution and use levels ; e.g. cryogenic storage management, electrolysis modelling, fuel cell, combustion and heat exchanger)
- Design and prototyping of specific equipment: H2 injectors, hydraulic valves, exchangers
- Surrogate models for real time simulations (digital twins)
- Fluid, structural and thermodynamic analyses related to H2 applications
- H2 combustion simulations
- Structural analyses (Eurocodes, dynamic analysis, safety assessment)
- Modelling of composite pressure vessels

Our link with hydrogen

- GDTech is involved in several projects on using modeling and simulation (at system and detailed levels) to support the efficient deployment of H2-based solutions (cryogenic storage management, composite tanks sizing, electrolysis, H2 combustion...).

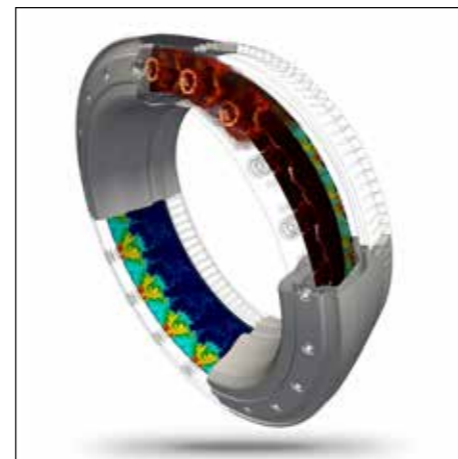
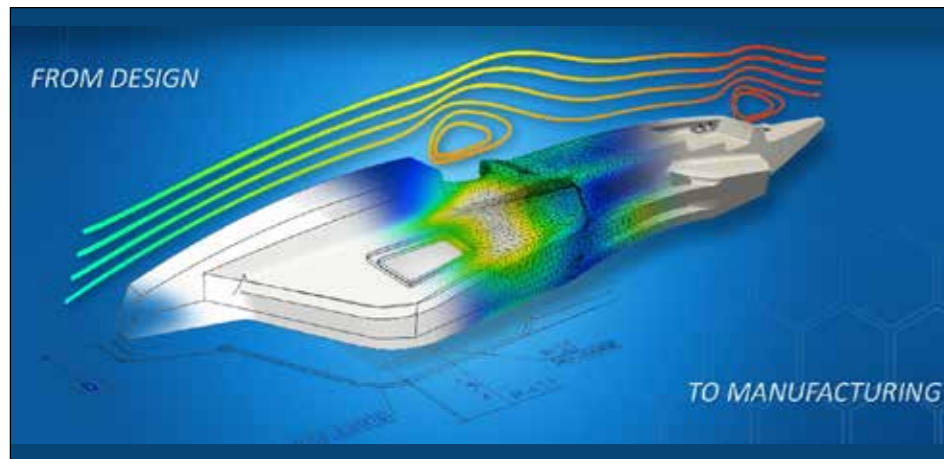

○Research & Training ○Production ○Transport, dist & storage ○Technology ○Engineering & integration ○Application ○End User

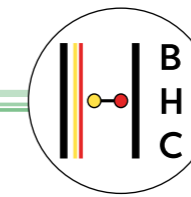
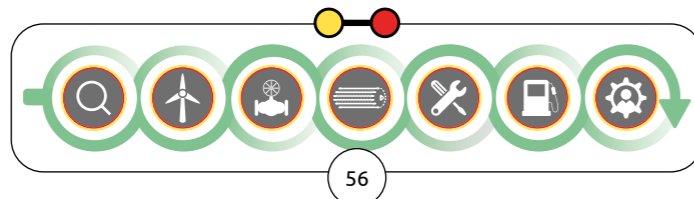

Ghent University
<https://www.energhentic.be/hydrogenplatform>
 Louis Sileghem
 louis.sileghem@ugent.be

Our activities

Ghent University provides top-notch research in the domain of energy with hydrogen, as part of the solution towards a carbon free society, as one of our research focal points. All UGent hydrogen research is gathered in the Hydrogen Platform.

The Ghent University Hydrogen Platform focuses on multidisciplinary valorization opportunities for hydrogen. It is committed to making the hydrogen expertise within Ghent University visible and to setting up partnerships and collaborations, both internally and externally. The Hydrogen Platform is an IOF platform, which means, it is at the intersection of various research domains, meeting the increasing social and economic importance of interdisciplinarity.

The Platform also offers an advanced course on hydrogen for professionals, organizes networking events & is involved in the initiation and follow-up of H2 research projects.

The Platform is a collaborative structure within Ghent University, so it has a broad scope and is firmly imbedded in EnerGhentIC (the multidisciplinary community of Ghent University innovating our energy future in partnership with industry and policy makers), the Centre for Sustainable Chemistry (CSC), CAPTURE, Metals, CleanChem and ChemTech.

Our link with hydrogen

- The Ghent University Hydrogen Platform focuses on multidisciplinary valorization opportunities for hydrogen



○Research & Training ○Production ○Transport, dist & storage ○Technology ○Engineering & integration ○Application ○End User

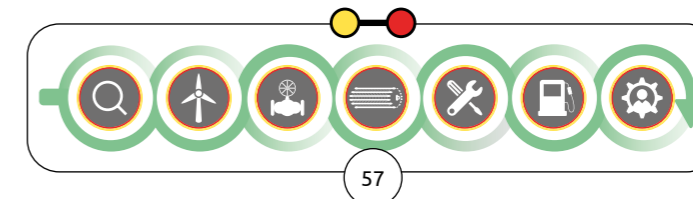



H2life - Public Interest Scientific Foundation
www.h2life.org
 Karen Rodrigues
info@h2life.org



Our activities

H2life is a scientific foundation whose mission is to promote objective information about renewable energy and the use of hydrogen as energy vector. Using renewable energies and hydrogen will help us to protect our climate, to reduce air pollution as well as noise, to support the local economy, to facilitate energy independence and to reduce the true costs of energy. H2life is a non-profit scientific and philanthropic organization, recognized as of public interest by the Belgian Ministry of Justice. It was established in 2011 by Dr. Philippe Lorge, scientist, founder of the greentech H2WIN S.A. Illustrative philanthropic actions of H2life :

- Organisation of events, such as conferences mainly in high schools and universities, in order to raise public awareness on issues such as climate change, and to provide information on how the use of hydrogen-based technologies can reduce the emissions of the gases that cause climate change;
- Publishing scientific information about climate change and hydrogen economy in formats accessible to the general public. These organizations have already called for H2life's advice or conference: Région Wallonne, Agoria, Lyons Club, Rotary Club, Mines Paris-PSL, University of Birmingham, etc.

Our link with hydrogen

- H2life promotes public awareness about hydrogen economy with scientific information since 2011.



○Research & Training ○Production ○Transport, dist & storage ○Technology ○Engineering & integration ○Application ●End User

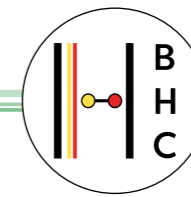
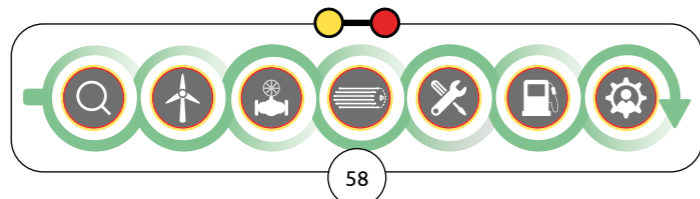

H2WIN S.A.
<https://www.h2win.com/>
 Mme Karen Rodrigues
h2win-info@h2win.com



Our activities

H2WIN is a Belgian Greentech company founded in 2013 by Dr. Philippe Lorge, an expert in enzymatic solutions with a unique know-how in the development of enzymatic systems from renewable sources using the biomimicry principles. Its products are dedicated to industrial applications and to the hydrogen economy.

H2WIN has patented an innovative technology to produce hydrogen from the direct conversion of sunlight and water with photosynthetic enzymes. What we call H2GREEN -Enzymatic Hydrogen Solar Panel.

Our first commercial development is for PEM Electrolyzer. H2WIN will produce enzymatic catalysts to replace the platinum catalyst coated on Membrane Electrode Assembly (MEA). Our enzymatic systems are produced with existing industrial biotechnology line and are compatible with existing coating line. Bio-MEA will be a game changer for the green hydrogen industries.

H2WIN works in close collaboration with academic institutions, technical institutes and innovative companies. This gives us the best balance of flexibility, competence and excellence in key areas. H2WIN is financially supported by the European Commission and the Walloon Region.

Our link with hydrogen

- We develop biotech solutions inspired by nature to produce green hydrogen and electricity

Raising awareness of new leader's generation about H2 economy

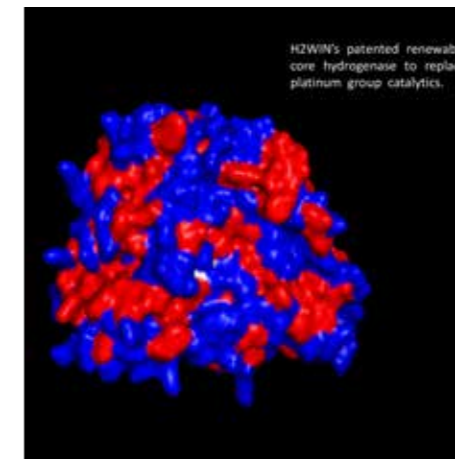

○Research & Training ●Production ○Transport, dist & storage ●Technology ○Engineering & integration ●Application ○End User

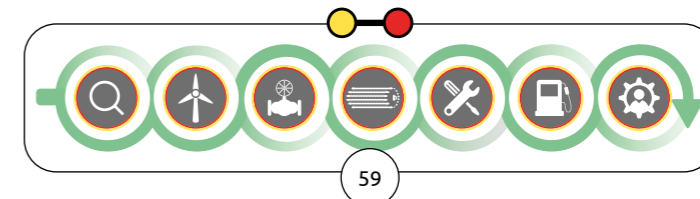



HAESAERTS INTERMODAL
 [member of ALTREA LOGISTICS GROUP]
 www.altrea.com
 Luc Haesaerts
 lhaesaerts@haesaerts.be

Our activities

The Altreia Logistics Group offers logistics solutions for various industries (Automotive, Steel, Waste & Recycling, Chemical industry).

Since 2021, two members of the Altreia Logistics Group, Haesaerts Intermodal and Trafuco are working closely together as Altreia Bulk & Liquids. Their synergistic activities forms this strong entity providing synchromodal transport of chemical liquids, oils, cryogenic gases, hazardous and non-hazardous waste.

Altreia Bulk & Liquids worked out an ESG program with a number of concepts to make transportation as sustainable as possible. An important pillar in the strategy are the investments in low emission heavy trucks reducing CO2 emissions up to 98%, in light weight chassis, composite and smart tanks.

Today, our sustainable fleet already operates the first H2 dual fuel trucks. The dual fuel truck is fuelled 80% hydrogen and 20% diesel, bringing 80% emission reductions. On 14 September 2022, we unveiled the 2.1 version, which consumes 80% hydrogen and 20% hydrated vegetable oil (HVO), which is a much cleaner fuel, and can perfectly replace today's diesel. By replacing diesel with HVO, CO2 is reduced by 98%.

Our link with hydrogen



○Research & Training ○Production ●Transport, dist & storage ○Technology ○Engineering & integration ○Application ○End User

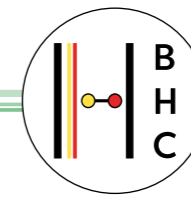
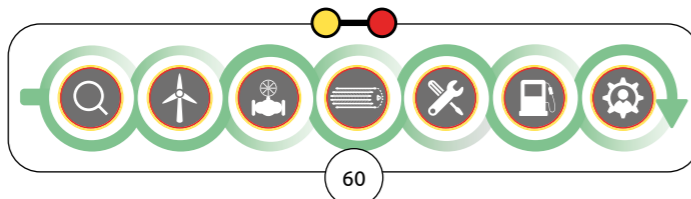

Helicus
 https://helicus.com/
 Mikael Shamim
 Mikael.Shamim@Helicus.com

Our activities

Helicus develops integrated unmanned aviation solutions for medical, inspection and off-shore use cases. This is done by coordinating a large group of leading aviation and healthcare actors to integrate their individual solutions, as well as through the development of specific technological and procedural components by Helicus. Main development is focused on our drone cargo port which serves as the ground station for all drone missions. Having the capabilities of automatic landing and take-off, use case depended payload swapping and automatic EV charging-Hydrogen refueling, the Drone Cargo Port enables flight mission readiness at remote locations.

Parallel to technical development, Helicus developed expertise in the field of consortia management and project coordination through our seven funded federal and European projects. These project have let to Helicus becoming the first operator in the EU to obtain the operational authorization to fly Beyond Visual Line Of Sight (BVLOS) over populated area.

Our link with hydrogen

- We in house developed an automatic hydrogen refueling system for drones. We want to include this refueling component in a full value chain by collaborating with other organization sin the field.



○Research & Training ○Production ○Transport, dist & storage ○Technology ○Engineering & integration ●Application ●End User

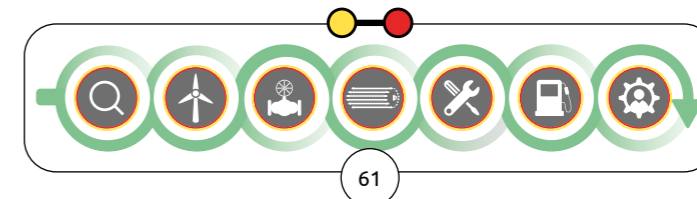



HGK Logistics Antwerp BV
 www.hgkshipping.de
 An Van Hooydonck
 an.vanhooydonck@hgkgroup.de

Our activities

HGK Logistics Antwerp is a subsidiary of HGK Shipping, Europe's leading inland waterway shipping company. With a fleet of more than 350 company and chartered vessels, HGK Shipping transports approximately 43 million tons of freight every year.

HGK Shipping believes that sustainable transport solutions are indispensable for the long-term development of inland waterway shipping. At its own Shipping Design Center they are working on concepts for alternative drive systems which include diesel-electric hybrid drive systems for new ships already on order as well as design studies for purely electric or hydrogen-powered inland waterway vessels.

With the construction of a completely new type of ship, HGK Shipping will be able to transport gases in both cold liquefied and pressurized liquefied form. This ship sets new standards for the safe and efficient transport of ammonia from "green" hydrogen and for the removal of unavoidable carbon dioxide.

Our link with hydrogen

- We are interested in the transport of ammonia or liquified CO2 for our customers as well as using hydrogen as a power source to use for our own fleet.



○Research & Training ○Production ●Transport, dist & storage ○Technology ○Engineering & integration ○Application ●End User

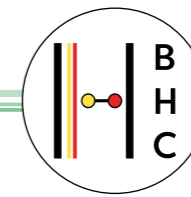
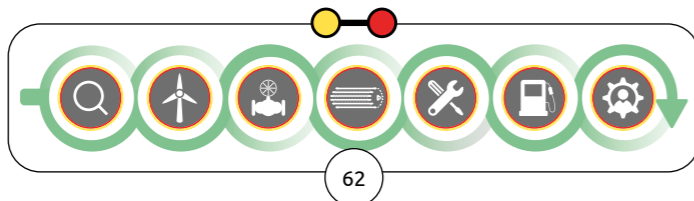

I.C. IPALLE
 www.ipalle.be
 Stempnick Sébastien
 sebastien.stempnick@ipalle.be

Our activities

PALLE is the environmental management intermunicipal company active in Picardy Wallonia and South Hainaut. Ipalle manage a waste-to-Energy plant, located in Thumaide, for the treatment of non-hazardous industrial as well as residual household waste.

Our link with hydrogen

- waste-to-wheels (transform waste into renewable fuel, where hydrogen is produced near the waste-to-energy plant and use locally for various mobility applications. The aim is a zero-emissions solution to decarbonize heavy duty vehicles and captive fleets that typically burn significant amounts of fossil fuels in the cities.

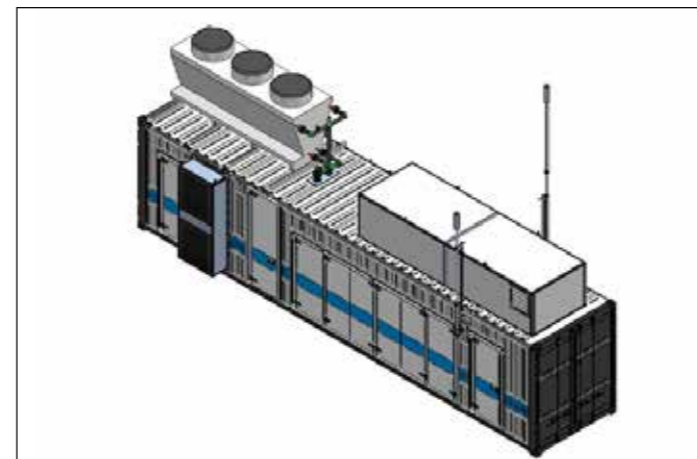

○Research & Training ●Production ○Transport, dist & storage ○Technology ○Engineering & integration ○Application ○End User

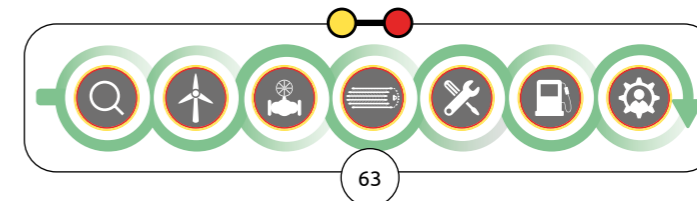



INFRA GROUP
<https://www.infra-group.eu/>
 Bertrand Jardinot
 bertrand.jardinot@verbraeken-infra.eu

Our activities

Infra Group makes connections every day. That is our job.

We provide critical infrastructure for Utility companies and for a wide range of Industrial customers (pharma, petro-chemical, logistics,...): Telecommunications, Electricity, Hydrogen, Gas, Water, Urban heating, Sewers, Public lighting,...

From the preliminary study, the permits, the execution right through to maintenance, Infra Group takes the weight off its customers' shoulders with a smart, multi-utility approach.

The strength of the group is our extensive and versatile network of companies. This enables us to create a unique pool of highly qualified experts. The right skills for the right project, that is our philosophy.

This multi-utility approach makes it possible to realise both small, large and complex turnkey projects. Even though we are operating in Europe, our international strategy goes hand in hand with strong local roots.

In 2023, Infra group is the contractor for 2 projects in Belgium for the installation of a Multi-purpose pipeline for gas and hydrogen for a total of 13,5km.

Our link with hydrogen

- Infra Group is a one-stop shop for design and build of public and industrial multi-utility infrastructure in Europe.



○Research & Training ○Production ●Transport, dist & storage ○Technology ○Engineering & integration ○Application ○End User

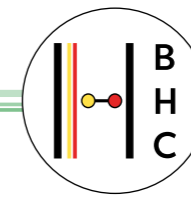
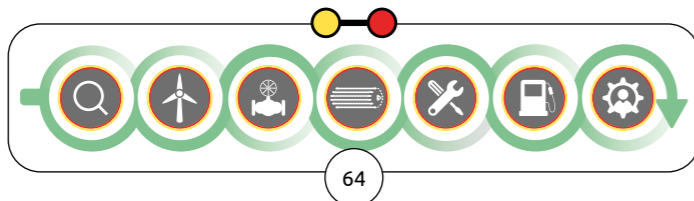

Infrabel
www.infrabel.be
 Pieter Jacqmaer
 pieter.jacqmaer@infrabel.be

Our activities

Infrabel is the Belgian railway infrastructure manager. It builds, maintains and operates the Belgian railway system. Its clients are railway operators that provide passenger or freight train traffic.

Currently, it does not have any hydrogen activities, but Infrabel intends to stay informed about recent hydrogen developments, advantages and applications so that a more concrete hydrogen strategy can be implemented when it is deemed beneficial.

Our link with hydrogen

- Infrabel researches whether hydrogen can be used to power trains or service vehicles, or whether and how it can be used to provide value for the company or regarding its link with its stakeholders.



○Research & Training ○Production ○Transport, dist & storage ○Technology ○Engineering & integration ○Application ●End User

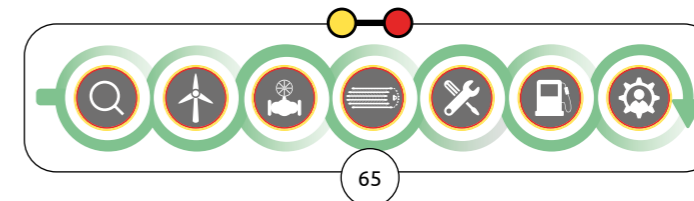



Intertek Belgium NV
<https://www.intertek.com/hydrogen/>
 Peter Gysen
 peter.gysen@intertek.com

Our activities

Intertek is a leading Total Quality Assurance provider to industries worldwide. Our network of more than 1000 laboratories and offices in more than 100 countries, delivers innovative and bespoke Assurance, Testing, Inspection, and Certification solutions for our customers' operations and supply chains. Intertek TQA expertise delivered consistently with precision, pace and passion, enabling our customers to power ahead safely.

Intertek Hydrogen provides customers with access to our unmatched expertise, pioneering energy innovations and global end-to-end risk-based quality, safety, and sustainability solutions that help them advance the hydrogen sector, successfully develop and execute hydrogen-based projects and create viable ecosystems all while overcoming safety challenges and increasingly complex regulatory requirements throughout the entire hydrogen value chain.

- Total end-to-end quality, safety and sustainability solutions for the entire hydrogen industry lifecycle, covering production, distribution, storage and end use applications phases
- Extensive global network of trusted experts and risk-mitigating technical services
- Leadership in pioneering innovation and ATIC services

Our link with hydrogen

- Long-standing history in the energy industry and unwavering support for global companies as they navigate the energy transition

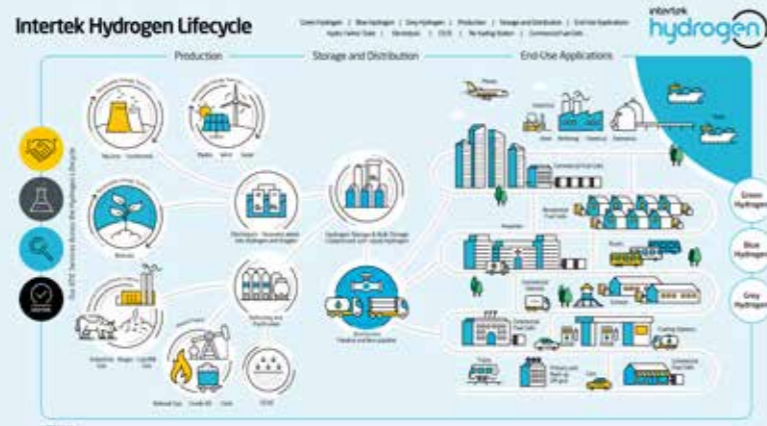

○Research & Training ○Production ○Transport, dist & storage ○Technology ○Engineering & integration ○Application ○End User

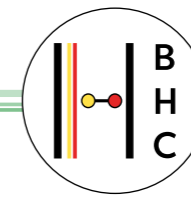
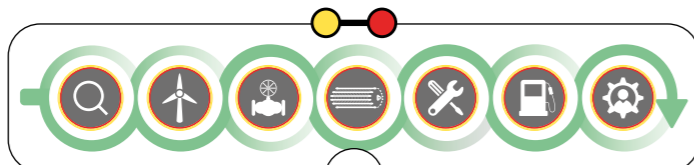

IPCOS
www.ipcos.com
 Christiaan Moons
 christiaan.moons@ipcos.com

Our activities

IPCOS is a Digital Solutions and Services provider, focused on maximizing plant efficiency, increasing business productivity, and enhancing environmental sustainability, through the smart application of latest Industry 4.0 technologies.

IPCOS serves a wide range of international process and allied industries such as chemicals, fertilizers, gas processing, upstream oil & gas, refining, petrochemicals, pharmaceuticals, power, waste and utilities.

IPCOS is already offering optimization solutions for more than 25 years on traditional hydrogen/ammonia/methanol plants (SMR/POX). Nowadays we are also optimizing future proof (green/blue/...) versions of these processes. IPCOS provides performance guarantees for the offered optimization solutions. We work for end users and the main process licensors around the world.

The keys to IPCOS' success are deep process- and domain knowledge combined with extensive technology know-how. IPCOS experts provide technical consultancy and implement tailor-made solutions to enhance efficiency and speed of decision making.

IPCOS engineers operate from 7 offices around the world (Belgium, Netherlands, UK, US, India (2x) and UAE).

Our link with hydrogen

- IPCOS is already offering optimization solutions for more than 25 years on traditional hydrogen/ammonia/methanol plants (SMR/POX). Nowadays we are also optimizing future proof (green/blue/...) versions of these processes.



○Research & Training ○Production ○Transport, dist & storage ○Technology ○Engineering & integration ○Application ○End User

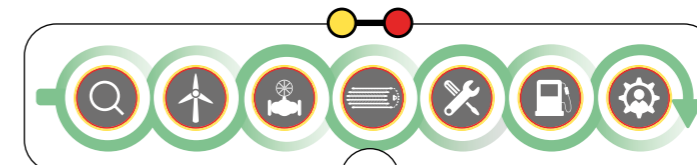



Jan De Nul
www.jandenul.com
 Jan Grommen
Jan.Grommen@jandenul.com

Our activities

Jan De Nul Group shapes both water and land. We enable the production of offshore energy and maintain the depth of waterways. We build new ports and create extra land. We realise complex infrastructure works and erect any type of building. We tackle pollution in whatever form. Thanks to the fruitful interaction within our company, we can offer overall solutions that combine one, several or even all these activities.

As the only company in our sector, Jan De Nul Group has an in-house multidisciplinary engineering division that can execute and follow up all types of project and equipment design. These in-house engineering capabilities enable us to be an all-in partner for our clients, from well ahead of the start of a project up to its complete execution. It gives us the edge to design tools and installations ourselves.

Jan De Nul is active as both a developer and contractor in various hydrogen projects. In Belgium, we are one of the partners behind Terranova Hydrogen, a H2 project in the North Sea Port powered by locally produced renewable energy. By installing offshore wind farms, interconnected grids, renewable energy infrastructure and hydrogen facilities, Jan De Nul is truly empowering the energy transition.

Our link with hydrogen

- Jan De Nul is strongly linked to the emerging hydrogen industry as both contractor and developer. We are globally involved in multiple hydrogen projects, constructing the necessary infrastructure for the production and export of green molecules. Closer to our home base, we are actively involved in Terranova Hydrogen, a hydrogen project in the North Sea Port powered by locally produced renewable electricity (solar and wind).



○Research & Training ●Production ●Transport, dist & storage ○Technology ●Engineering & integration ○Application ●End User

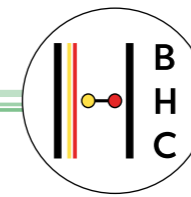
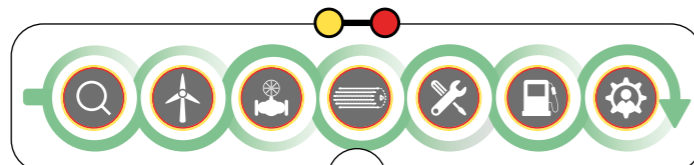

Jema
<https://www.jema-power.com>
 Vincent Berghmans
vincent.berghmans@jema.be

Our activities

Established in 1937, JEMA designs, develops and manufactures high performance power supplies for various sectors including industry decarbonisation processes, electrolysers, particle science, metallurgy, industry, infrastructure equipment, electrical network,... among others.

Founding its reputation on a spirit of excellence and on continuous dialogue with its customers, JEMA has acquired during the last 50 years an exclusive knowledge of DC power supplies and subsidiary power applications in relation with customer's specific requirements.

The competences of JEMA range from kW to multi MW applications, going from low to high voltage (several kV), low to high current (several kA), precision and long term stability down to some ppm, with high efficiency and to be easily connected to the grid. Engineering experience, careful selection of components, up-to-date technology intelligence, smart regulation systems, integrated industrialization are all parts of the outstanding JEMA position of leading actor in its field.

Our link with hydrogen

- From prototype to industrialization, JEMA follows their customers by finding the best solutions for energizing electrolyszers of all power levels and technologies.



○Research & Training ●Production ○Transport, dist & storage ●Technology ●Engineering & integration ○Application ○End User

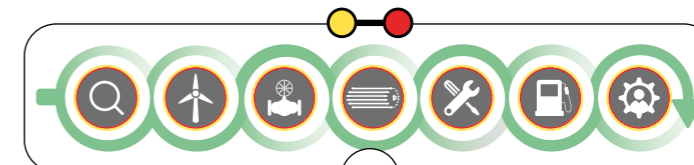



John Cockerill Hydrogen
<https://hydrogen.johncockerill.com/en/>
 Jean-Claude BIDAUT
jean-claude.bidaut@johncockerill.com

Our activities

The John Cockerill Group develops large-scale technological solutions to meet the needs of its time: facilitating access to fossil free energies, enabling sustainable industrial production, preserving natural resources, contributing to greener mobility, enhancing security and installing critical infrastructures. Its offer to companies, States and communities consists of services and associated equipment for the sectors of energy, defence, industry, the environment, transports, and infrastructures.

With decades of experience in hydrogen technologies, John Cockerill Hydrogen, a fully owned subsidiary of John Cockerill, is a world leading electrolyzer manufacturer with a broad offering from power source to gas separation, purification and balance of plant. The company designs, builds and maintains pressurized alkaline electrolyzers of up to 6.5MW capacity stacks (1300Nm³ per hour) – among the world’s largest – and has delivered ~80 stacks of 5MW or above since 2018. Through its existing manufacturing footprint and its planned global capacity ramp-up, John Cockerill Hydrogen is uniquely positioned to lead the fast-growing green hydrogen production market with specific focus on industrial-scale and utility-scale projects.

Our link with hydrogen

- John Cockerill Hydrogen offers best-in-class alkaline electrolyzers technology, ready for large-scale projects and integrated solutions from production to mobility facilities.



○Research & Training ○Production ○Transport, dist & storage ●Technology ●Engineering & integration ○Application ○End User

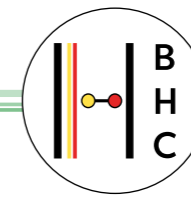
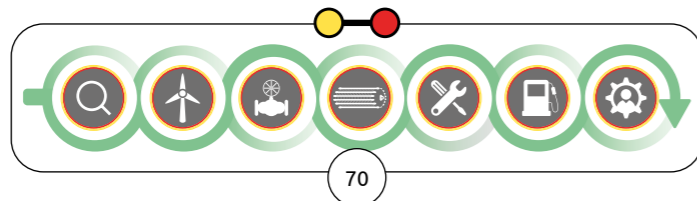

KIOZ NV
www.kioz.be
 Trees Loncke
trees.loncke@kioz.be

Our activities

With Kioz we offer solutions for:

1. the decentralized generation of green energy
2. storing energy in battery systems
3. processing surplus energy into hydrogen
4. offering applications where hydrogen can be consumed on site.

Both the stored energy and the energy converted into hydrogen are essential in our ultimate goal: total energy independence. This is very broad and includes not only electricity, but also mobility and heating. Energy independence ensures that your company is not affected by fluctuations in energy price and quantity and it responds to the growing problem of grid congestion. All this is also part of a further necessary defossilization, since all our generated energy is by definition local and green.

Our link with hydrogen

- the hydrogen way to energy autonomy



○Research & Training ●Production ○Transport, dist & storage ●Technology ○Engineering & integration ●Application ○End User

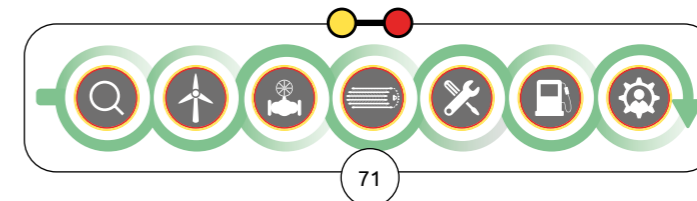

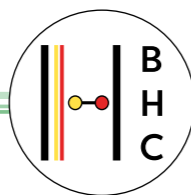

KROHNE

KROHNE Belgium
<https://be.krohne.com/en>
Ludo Van Eeckhoudt
l.vaneekhoudt@krohne.com

Our activities

KROHNE is a leading system provider in the field of industrial process measurement instrumentation. Supporting the energy transition and sustainability is at the top of KROHNE's agenda. Our goal is to assist our customers in the challenges posed by hydrogen with our know-how and technologies. Custody transfer compliant meters and flow computers for hydrogen and hydrogen-containing gas mixtures are required as part of the energy transition. Our ALTOSONIC V12 flowmeter, equipped with epoxy-based transducers, remains resilient to hydrogen embrittlement even under high-temperature conditions, where the SUMMIT 8800 integrates specialized H2 algorithms to accurately perform calculations. It is the first flow computer on the market to be fully certified by NMi for hydrogen applications. Pipeline management with PipePatrol is one of the most accurate leak detection system (LDS) on the market and provides precise leak information for a high level of safety.

Our link with hydrogen

- We measure everything, everywhere!



○Research & Training ○Production ○Transport, dist & storage ●Technology ●Engineering & integration ○Application ○End User

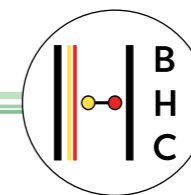
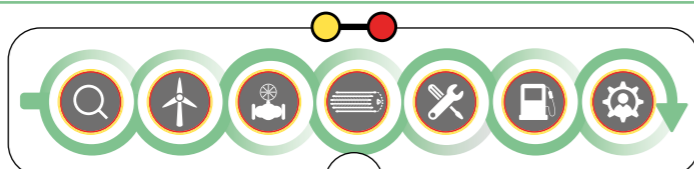

KU LEUVEN

KU Leuven
www.kuleuven.be
Marion Bechtold
marion.bechtold@kuleuven.be

Our activities

KU Leuven is an international community where innovative research forms the basis of all our academic programmes. Across the university, driven researchers and curious students continually gain new insights and use their knowledge to tackle the foremost challenges of our time. At KU Leuven, several research groups are active along the hydrogen value chain. This covers the production phase, storage, distribution and use phase, as well as whole grid considerations. Examples are: membranes for hydrogen production, power electronics for electrolyzers, inorganic materials (clathrates) and liquid organic hydrogen carriers (LOHC) for hydrogen storage and distribution, advanced characterization and simulation tools for investigating hydrogen embrittlement, design and reliability of hydrogen pressure vessels including failure monitoring, (solar) power to ammonia and electrocatalytic conversion of ammonia to hydrogen, use of hydrogen for heat and power engines, use of hydrogen in metallurgical processes, (hybrid) offshore energy conversion networks and integrated energy system modelling.

Our link with hydrogen

- We offer expertise in hydrogen research along the full value chain.

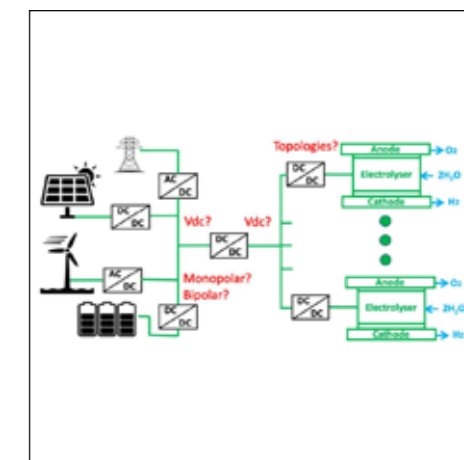
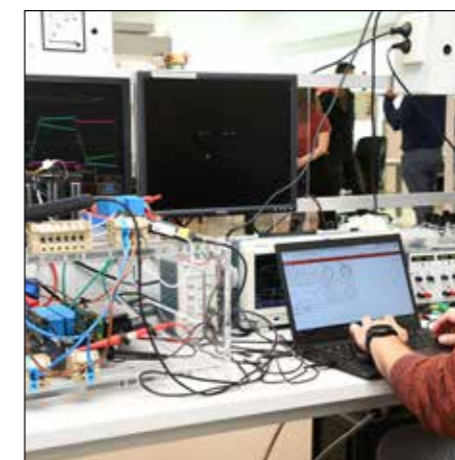
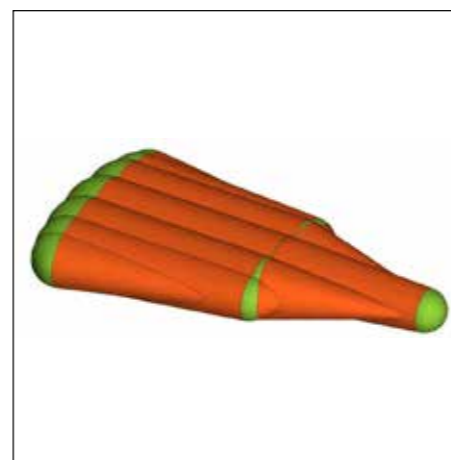

●Research & Training ●Production ●Transport, dist & storage ●Technology ○Engineering & integration ○Application ○End User

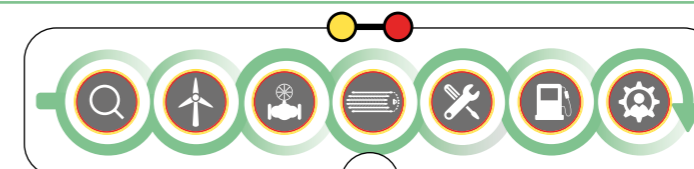



LRQA
<https://www.lrqa.com/nl-be>
 Pascal Steiner
 e-mail pascal.steiner@lrqa.com

Our activities

As the world moves to other alternative energy sources, the use of hydrogen to supplement the fossil fuel supply or completely replace the use of natural gas is increasing.

From Approval in Principle to Type Approval and Vendor Assessments - LRQA range of services provide assurance around equipment adaptation and manufacture, while also helping you stay ahead of incoming standards which are developing quickly. We also offer a Certificate of Origin to provide assurance on the quality and type of hydrogen that is being purchased.

We'll work closely with you, helping you navigate the impact of a changing regulatory landscape, as well as the challenges relating to facilities, and the production, storage, and distribution of hydrogen as it moves into the energy mainstream.

Our link with hydrogen

- LRQA can offer a full modularised hydrogen assurance solution in the following areas:
 Approval in Principle, Certificate of Origin, Net-zero manufacturing assurance, Hydrogen Standards Training



Research & Training Production Transport, dist & storage Technology Engineering & integration Application End User

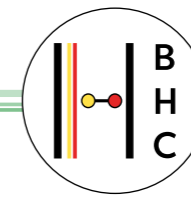
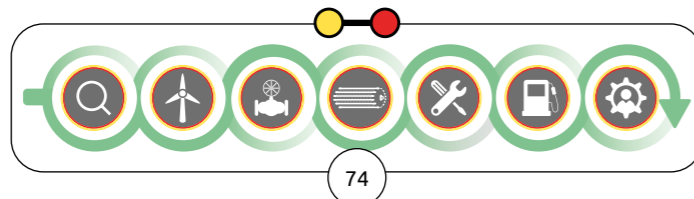

Luminus
www.luminus.be
 Kristof Vanhoorne
kristof.vanhoorne@luminus.be

Our activities

Luminus is the number one in onshore wind and hydro power in Belgium and thus a major player in renewable energy and electrification. Bringing innovative and CO2-neutral solutions to the energy market lies at the core of the group's strategy.

Luminus, as developer of renewable energy projects, is offering clients a partnership for the production and supply of hydrogen.

Our know-how related to hydrogen :

- Production, supply and management of renewable electricity
- Development and implementation of energy projects from A-Z (development, financing, construction, operations and maintenance)
- Expertise in electrification and maintenance via our Belgian subsidiaries (ATS, Newelec and Luminus Solutions)
- Expertise in hydrogen production and electrolysers within the EDF Group (EDF R&D, Hynamics, ...)

This know-how enables us to be an ideal partner for the development of hydrogen projects in Belgium, with the support of the EDF group, and in close cooperation with local partners and regions.

Our link with hydrogen

- Luminus, as developer of renewable energy projects, is offering clients a partnership for the production and supply of hydrogen.



Research & Training Production Transport, dist & storage Technology Engineering & integration Application End User

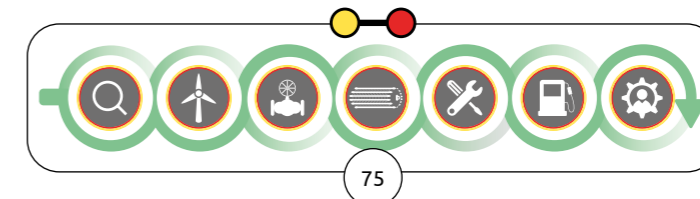



Luyckx
www.luyckx.be
 Mathias Goris
mathias.goris@luyckx.be

Our activities

Since 1952, Luyckx has been known as specialist in the distribution and servicing of machinery for civil engineering, material handling and agricultural applications. Luyckx only distributes top brands and is an important reference in the sector of construction for special applications.

To address the growing demand for sustainability from our clients, we developed a dual fuel hydrogen excavator in collaboration with CMB.TECH back in 2020. Additionally, we maintain a close relationship with our manufacturers who are continuously advancing in the development of hydrogen-related applications. We aim to have a leading role of promoting sustainability in civil engineering machinery in Belgium.

Our link with hydrogen

- Being a first solution provider for our customers within civil engineering. Due to the nature of our machines, this will definitely include hydrogen.



○Research & Training ○Production ○Transport, dist & storage ●Technology ●Engineering & integration ○Application ●End User

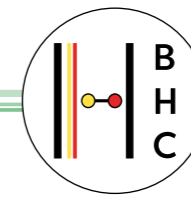
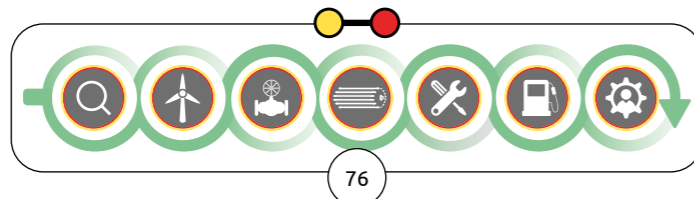

Materia Nova
<https://www.materianova.be/fr/>
 Fabrizio Maseri
fabrizio.maseri@materianova.be

Our activities

Materia Nova is actively working on 'Advanced Materials' products and on innovative and cost-effective processes to produce clean hydrogen, going beyond conventional processes and feedstocks. We are convinced by the importance of developing cost-effective alternative technologies to valorise clean hydrogen and by-products by starting also from others local feedstocks. We are leading research and innovation for Clean and Secure systems integrating H2 and other vectors production/conversion, their storage, transport and uses. We are committed to our industrial partners on their preparation for the massive integration of sustainable processes and strategic choices in the decarbonization process in future energy systems.

Materia Nova has strongly supported UMONS for obtaining the granted proposal called «TRL7 Plug&Tests» that targets a unique interconnection of decarbonization technologies on an industrial site to demonstrate the effective operation of various modular energy communities at a pre-industrial scale. Materia Nova has also decided a robust intellectual property protection, filing pivotal patents annually and managing freedom-to-operate aspects.

Our link with hydrogen

- Our focus lies in the advancement of materials and processes essential for generating decarbonated useful forms of energy. In addition, we are specialized in the creation of innovative materials such as coatings and nanocomposite polymers designed for efficient transportation and storage of energy.



●Research & Training ●Production ●Transport, dist & storage ○Technology ○Engineering & integration ○Application ○End User

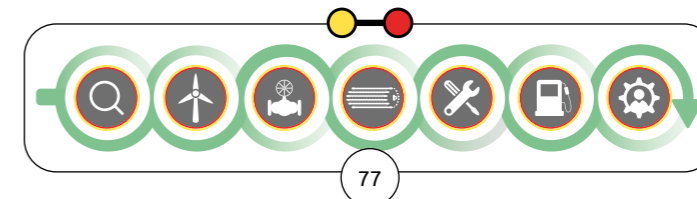



Messer Belgium NV
 www.messer.be
 Dirk De Keulenaer
 dirk.dekeulenaer@messergroup.com

Our activities

Messer is the world's largest privately held specialist for industrial, medical and specialty gases. As a global player, Messer offers its sustainable products and services in Europe, Asia and America.

Messer manufactures and supplies oxygen, nitrogen, argon, carbon dioxide, hydrogen, helium, specialty gases, medical gases and food gases as well as many different gas mixtures. Almost all industrial sectors, healthcare as well as science and research benefit from our products and application technologies.

With more than 125 years of extensive expertise in industrial gases, Messer has successfully established the safe production of hydrogen. Especially when it comes to hydrogen, Messer maintains strict quality assurance, masters filling technology and efficiently manages logistics and delivery, whether for cylinders, bundles, trailers or on-site production.

When you work with Messer, you're not just getting a supplier; you're getting a reliable partner in your hydrogen journey. We take safety seriously, ensuring that every hydrogen delivery is handled with the utmost care. Moreover, our close collaborations within the industry keep us in touch with the latest developments in hydrogen technology.

Our link with hydrogen

- Messer focuses on the development and supply of clean / low-carbon hydrogen to a wide range of industries, both in established sectors and emerging areas such as mobility and energy supply. As your partner, Messer can provide clean hydrogen along with associated technologies, including electrolyzers, hydrogen refueling stations, buffer storage capacities and more.



○Research & Training ○Production ○Transport, dist & storage ●Technology ○Engineering & integration ○Application ○End User

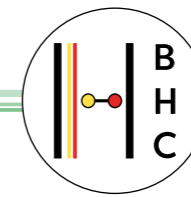
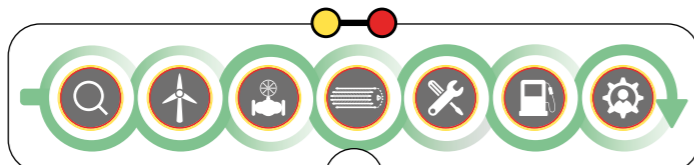

MITIS SA
 www.mitis.be
 Michel Delanaye
 michel.delanaye@mitis.be

Our activities

Mitis was founded in 2012 and specialises in the development of high-speed turbines (~100,000 rpm) and integration of such systems. Its products are by nature energy efficient, clean, sustainable due to the flameless combustion they are able to deliver. Mitis aims to increase the efficiency of decentralised fuel conversion by combining heating, cooling and electricity generation.

Mitis is developing products from the ground up with its in-house simulation and modelling skills, engineering capabilities in high-precision mechanics and electronics, and performance testing capacities. The company develops both its own products (cogeneration microturbines) and participates in specialized industrial projects with select partners. For example, Mitis is currently working for ESA to develop a 120 kW UPS (uninterruptible power supply) using a hydrogen fuel cell for use at the Kourou site in French Guiana.

Our link with hydrogen

- Development of high power fuel cells for stationary power generation applications. Development of hydrogen combustion technologies.



○Research & Training ○Production ○Transport, dist & storage ●Technology ○Engineering & integration ○Application ○End User

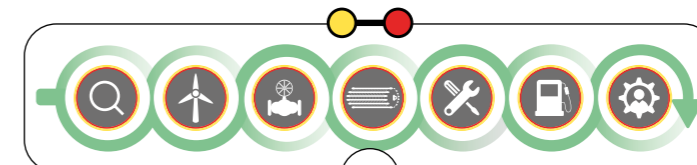



Nelissen Steenfabrieken
 www.nelissen.be
 Paul Sino
 paul.sino@nelissen.be

Our activities

Nelissen Steenfabrieken is a manufacturer of facing bricks. Since its foundation - 103 years ago - it has emerged from a local family business to a major player in the international market: Nelissen Steenfabrieken can produce 185 million bricks every year, in more than 100 colours and 8 formats.

Nelissen prioritizes the energy transition and is working on a climate roadmap with the development of alternative energy sources and the production of eco-formats for CO2 reduction.

The goal is to eventually transform the brick into a CO2-neutral product. Currently, Nelissen is exploring various options for sustainability, including renewable energy plants, alternative production methods and the transition to hydrogen. Fluxys is currently working on a proposal to develop a hydrogen pipeline between Ghent and Antwerp. The next project involves the hydrogen pipeline between Antwerp and Liège, which is planned from 2028. Nelissen's production site is located on the route of this H2 pipeline between Antwerp and Liège, allowing Nelissen direct access to the hydrogen pipeline. Nelissen's connection to the hydrogen pipeline is expected from 2030.

Our link with hydrogen

- Our primary challenge is to rapidly reduce our CO2 emissions by 42% before 2030, and targeting CO2 neutrality after 2030. We are focusing on energy transition to hydrogen, among other things, and exploring sustainable production options to ultimately deliver a CO2-neutral product and meet European climate targets.



○Research & Training ●Production ○Transport, dist & storage ○Technology ○Engineering & integration ○Application ●End User

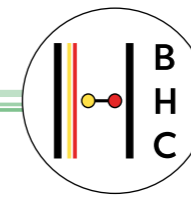
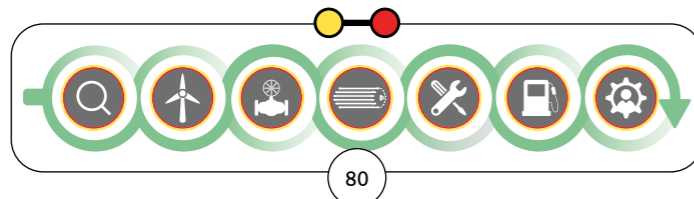

NEWELEC SA
 www.newelec.be
 Christophe LECLERCQ
 christophe.leclercq@newelec.be

Our activities

Renewable energies

Our shareholder Luminus (EDF Group) invests greatly in renewable energies such as HYDROGEN and spearheads the energy transition. Newelec is participating in this large-scale project by offering its expertise and services. With its a full range of services, Newelec is the ideal partner for all your electrotechnical projects.

We boast in-house technical know-how in areas such as electrical engineering, installation and maintenance in high and low voltage, cabinet production, automation and supervision as well as instrumentation.

Historically, industry represents Newelec's leading business sector in terms of experience and turnover. We are also present in the infrastructure and building sector to carry out all types of complex projects in electrical engineering.

Our link with hydrogen

- We're now busy in the Walloon Region on a prototype project with Luminus.



○Research & Training ●Production ○Transport, dist & storage ○Technology ●Engineering & integration ○Application ○End User

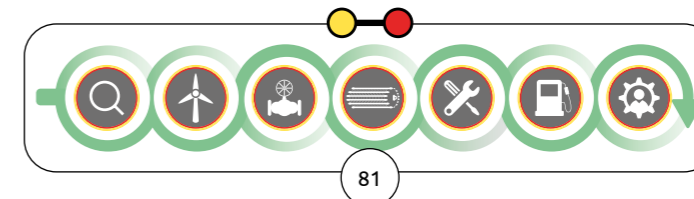

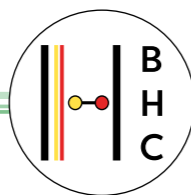

NIPPON GASES
<https://nippongases.com/be-nl>
 Pascal Meyvaert
pascal.meyvaert@nippongases.com

Our activities

Nippon Gases - part of Nippon Sanso Holdings Corporation - is present in more than 13 countries, counting with a solid combination of onsite/ piping, merchant and package lines of business across key industrial zones.

We are a strategic partner for industrial and medical gases in Europe.

We aim to create social value through innovative gas solutions that increase industrial productivity, enhance human well-being and contribute to a more sustainable future.

Proactive. Innovative. Collaborative. Making life better through gas technology. The Gas Professionals.

Nippon Gases is the fourth- largest industrial gas company in Europe with an overall market share close to 9% in the continent.

We help our customers in achieve safety and environmental sustainability standards, increase productivity, decrease energy consumption and produce higher quality products.

The main products supplied by Nippon Gases in various physical forms and purities are oxygen, nitrogen, argon, carbon dioxide, hydrogen, helium, carbon monoxide, gas mixtures, electronic gases, specialty gases and the services and technologies associated with the use of these gases and mixtures.

Our link with hydrogen

- To extend our portfolio of products we're developing a green hydrogen source on a brownfield in The North Sea Port. Hydrogen will be one of the carbon free alternative energy carriers of the near future.



○Research & Training ○Production ○Transport, dist & storage ○Technology ○Engineering & integration ○Application ○End User

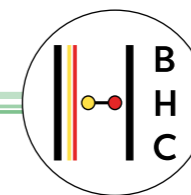
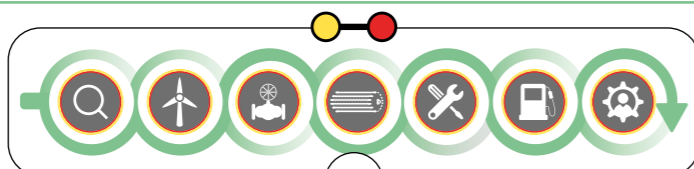

North Sea Port
<https://www.northseaport.com/>
 Charlotte Herman
charlotte.herman@northseaport.com

Our activities

North Sea Port 's location, multimodality and diversification in goods make North Sea Port an important European port: the third most important in terms of added value and the seventh in terms of goods traffic.

North Sea Port strives for sustainable economic activity with a high added value. To that end, the port actively contributes to the prosperity of the surrounding region.

The industry cluster at North Sea Port is the largest hydrogen hub in the Benelux region. Hydrogen will be playing an increasing role in making the industry and transport sector in and around North Sea Port more sustainable. If sustainable hydrogen is also produced on a large scale in other parts of the world, some of that hydrogen will be imported via North Sea Port. North Sea Port is centrally located in important pipeline corridors in both Belgium and the Netherlands, and its location at the mouth of the Western Scheldt also makes it a promising hub for bunkering sustainable fuels. In combination with large-scale local demand and sustainable production, good availability of space, landings of offshore wind power and the presence of deep sea port facilities, makes North Sea Port a hydrogen hub on a European scale.

Our link with hydrogen

- North Sea Port- A hydrogen hub on a European scale

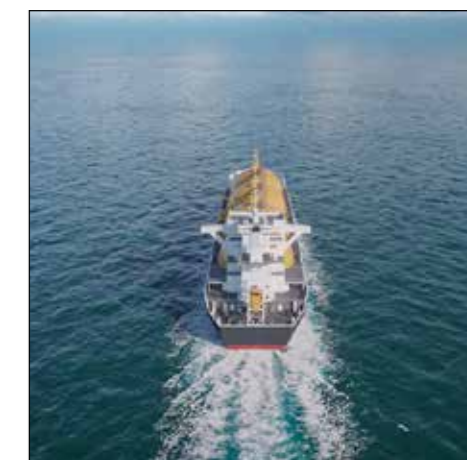
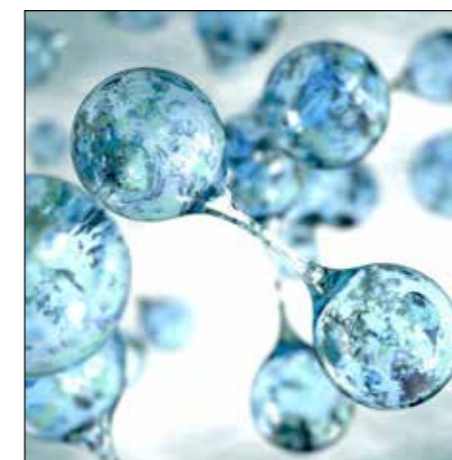

○Research & Training ○Production ○Transport, dist & storage ○Technology ○Engineering & integration ○Application ○End User

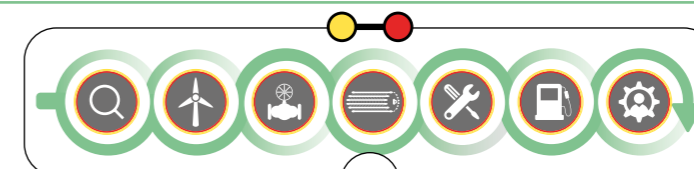



NOVANDI
 www.novandi.be
 Vincent Brassinne
 vincent.brassinne@novandi.be

Our activities

Novandi is specialized in multimodal transport & logistic in Belgium from Liège, Charleroi and Avelgem terminals. We connect Antwerp and Rotterdam to our inland container terminals by barge with more than 2 departures per day.

Novandi is very active in innovation with already 2 barges remote controled.

Multimodal transport is already a solution to aim our 2030 CO² reduction goals but Novandi wants to go further by retrofitting 2 barges and built a hydrogen production on the container terminal in Liège.

In association with other key player in hydrogen, go live is expected for end 2026.

Our link with hydrogen

- Solution of decarbonation for heavy equipments as barges.



○Research & Training ○Production ○Transport, dist & storage ○Technology ○Engineering & integration ○Application ●End User

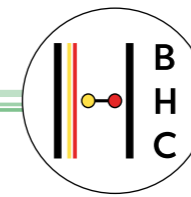
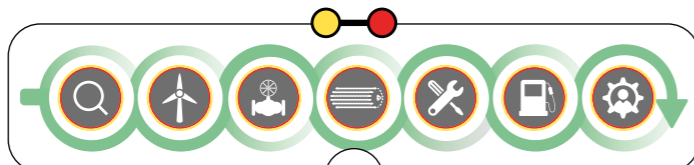

OCAS
 www.ocas.be
 Steven Keyzer
 steven.keyzer@ocas.technology

Our activities

OCAS is an industry-oriented R&D company for metals, coatings and their applications. We operate from our two Belgium based facilities and cooperate with sister companies in the FINOCAS group to solve the problems of our customers.

Related to its activities on Hydrogen, OCAS focuses on materials and components for transport and storage of H₂ and other carriers such as NG, LNG, NH₃, and CO₂. Amid energy transition, OCAS plays a major role in assisting towards reaching climate ambitions and decarbonisation targets.

Especially related to the interaction between Hydrogen and materials, OCAS has an internationally recognised expertise. We can model, test, understand and improve material behaviour in hydrogen environments related to your application. We can advise on material selection and exploitation conditions suitable for operation in hydrogen atmospheres. Our experts are involved in several projects at national and EU level, as well as in bilateral agreements with industrial customers.

To even better comply with customer requirements, OCAS is currently investing in a brand new lab for conducting material tests in high pressurised environments and replicate the industrial circumstances on materials in new H applications.

Our link with hydrogen

- OCAS is specialised in material research and development, including advanced testing, for Hydrogen applications.



○Research & Training ○Production ●Transport, dist & storage ●Technology ○Engineering & integration ●Application ○End User

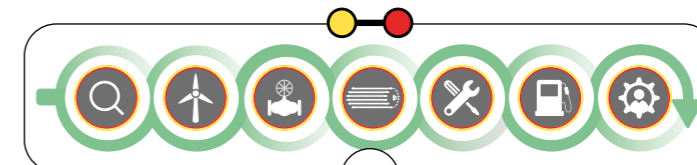



PFF BELGIUM NV
<https://www.pff-group.com/>
 Peter Heeman
 peter.heeman@pff-group.com

Our activities

The PFF Group, founded in 1992 as a division of the international operating Galperti Group, specialises in the supply of complete services for piping and valve projects. We offer high quality pipes, flanges, fittings and valves for the oil, gas, chemical, H2, petrochemical and power generation industries.

Within these markets, we want to be a strategic business partner and a 'platinum service provider' by distinguishing ourselves through quality and with our capability and flexibility to meet the needs of our customers. The primary objective of our service is to meet the market demand for technical solutions and high-quality products in the area of piping.

In order to be able to adequately meet the market demand, the PFF Group – as a specialist in the area of total project supply and project management – carries a wide standard range of pipes, flanges, fittings and valves that comply with ANSI, API specifications from stock. In addition, we supply a range of customer-specific products on request, which we specifically keep in stock for selected customers.

The PFF Group has a total of more than 20,000 unique products in stock.

Our link with hydrogen

- The PFF group has the experience and knowledge to supply dedicated piping material (pipes, fittings, flanges & valves) for the hydrogen market.

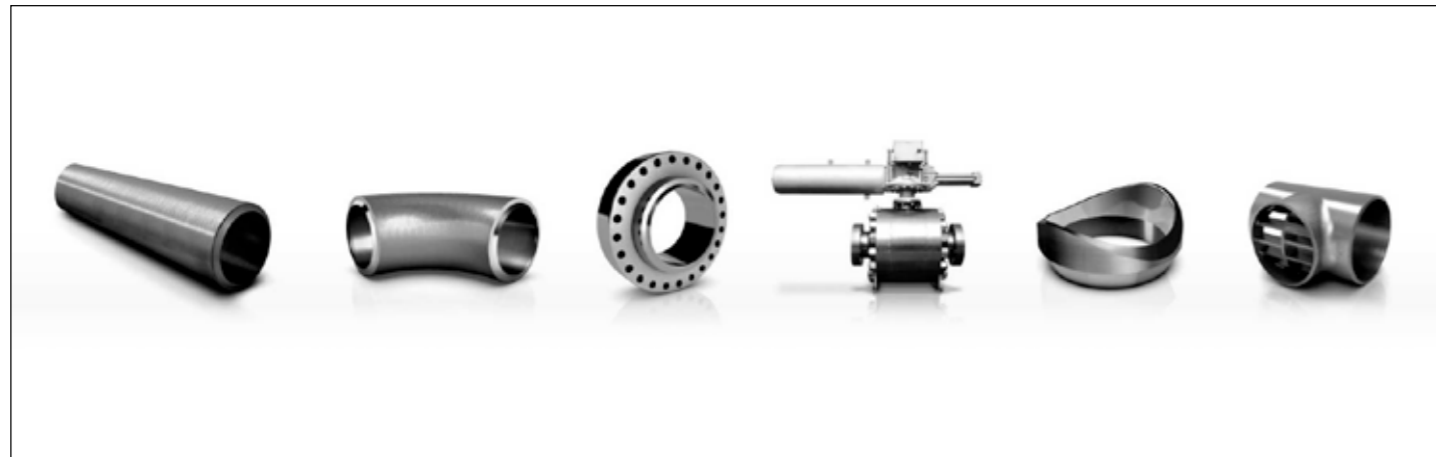

○Research & Training ○Production ●Transport, dist & storage ○Technology ○Engineering & integration ○Application ○End User

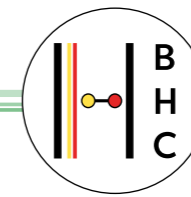
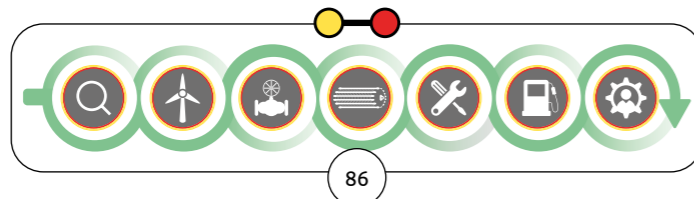

Plastic Omnium Genk
www.plasticomnium.com/en/technologies-new-energies/
 Jos Reeskens
 jos.reeskens@plasticomnium.com

Our activities

Plastic Omnium is a well known Tier I automotive supplier. Out of the Clean Energy System division, supplying fuel tanks and filler pipes to almost all car manufacturers, a new division was created in 2022: New Energies. This division concentrates on hydrogen solutions for all mobility applications, covering high pressure vessels, fuel stacks and fuel systems.

The technical center for the hydrogen pressure vessels (HPV) is situated in Genk. In this R&D center, the full development, manufacturing of prototypes as well as all testing for the hydraulic and pneumatic leg according the UN R134 directive is performed for these 700 bar vessels. The development is done with state of the art development tools, including CompositiCad, the winding software that is developed in house. All required research activities on the building blocks of these HPV's are also conducted in Genk, covering material science, as well as the process techno-bricks.

Once the HPV is certified, the mass production of the various HPV's is done in the Herentals plant. This plant is equipped to cover all the productions steps in a highly automated set up.

Our link with hydrogen

- Plastic Omnium New Energies will serve the mobility market with high pressure vessels as well as fuel stacks and systems, driving into a new generation of mobility.



○Research & Training ○Production ●Transport, dist & storage ○Technology ●Engineering & integration ○Application ●End User

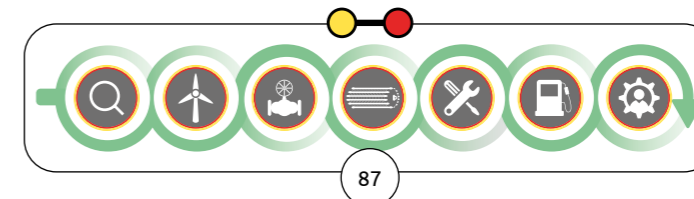



Polders Investeringsfonds nv
Antwerpse duurzame investeringsmaatschappij

Polders Investeringsfonds
<https://www.vleemo.be/>
Koen Van den Brande
koen.vandenbrande@pif.be

Our activities

Polders Investeringsfonds (further PIF) was founded in 1999 with the intention of realizing wind projects in the port of Antwerp. It was one of the pioneers in Flanders. PIF owns 50% of VLEEMO, the wind energy company that realizes the wind projects on the right bank of the Scheldt and participates through Polders Windfonds, a collaboration between FINEG and PIF, and VLEEMO in Wind aan de Stroom, the wind energy company that develops the wind projects on the left bank of the Scheldt. In this way, VLEEMO already manages 67 wind turbines in the port of Antwerp, representing an investment of more than 350 M EUR. Together with Ravago, PIF also operates 2 wind turbines in Arendonk that supplies power directly to the recycling plant. PIF also realizes other projects. For example, it invests in sustainable housing projects with a focus on people and the environment. PIF participates in the construction company Brebuild, which has built, among other things, the first passive school for the city of Antwerp. With a participation of PIF in Affect2U, this private initiative in addition care is being further expanded with branches in Hoboken and Vosselaar. PIF also owns quite a few agricultural lands on which organic agriculture is practiced in a future-oriented manner. PIF has also gained experience with the ecological management of sites in the port of Antwerp and has entered into a commitment to realize and manage a nature compensation project near the port of Antwerp. Recently, PIF has also taken the initiative to set up the Antwerp Biopolder Campus, which aims to offer training in organic agricultural techniques and sustainable energy.

Our link with hydrogen

- Production of H2 from renewable energy sources (wind energy)
- Application of H2 in agricultural energy systems



○Research & Training ●Production ○Transport, dist & storage ○Technology ○Engineering & integration ○Application ○End User

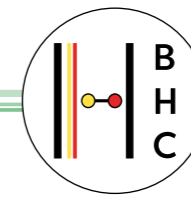
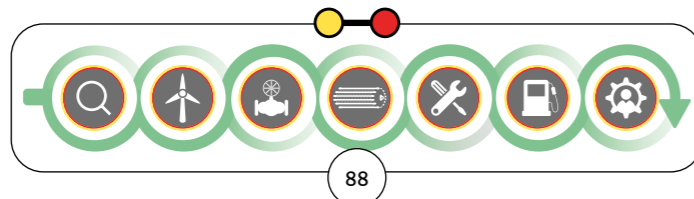

Port of Antwerp-Bruges
Maxime Peeters
Maxime.Peeters@portofantwerpbruges.com

Our activities

With more than 300 liner services and 800 destinations, Port of Antwerp-Bruges is the second largest port in Europe. It is an important lifeline for the Belgian economy. International connections and sustainable growth play an important role in reinforcing its role as a world.

As a port, Port of Antwerp-Bruges plays an important role in the local and international hydrogen chain by focusing on three pillars: supply and production of hydrogen, distribution infrastructure and consumption of hydrogen, and transport to end users in the hinterland.

To provide the port and all its users with safe, sustainable and affordable energy, we generate green electricity locally through solar panels and wind farms at sea and on land. In addition, we supplement local production of green electricity with local production of hydrogen and, in particular, by importing large volumes of sustainable hydrogen (carriers) such as liquid hydrogen, methanol, ammonia, synthetic methane and Liquid Organic Hydrogen Carrier. After all, some end users cannot fully electrify and need molecules, such as shipping or our raw materials and high-temperature heat production for chemistry. Hydrogen and its carriers provide a convenient form of transport and storage.

Our link with hydrogen

- Hydrogen is an important cornerstone in the energy and raw materials transition towards climate neutrality in 2050. Port of Antwerp-Bruges aims to be a leader as a European import hub of hydrogen and an active pioneer of the hydrogen economy.

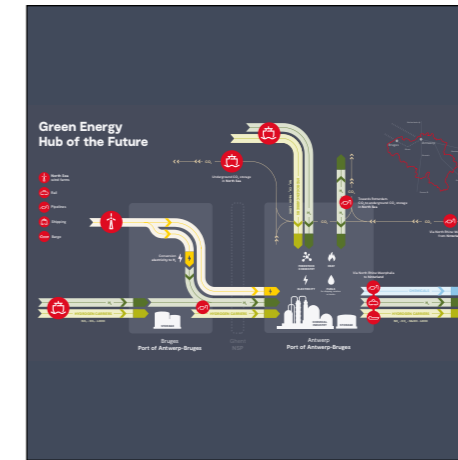
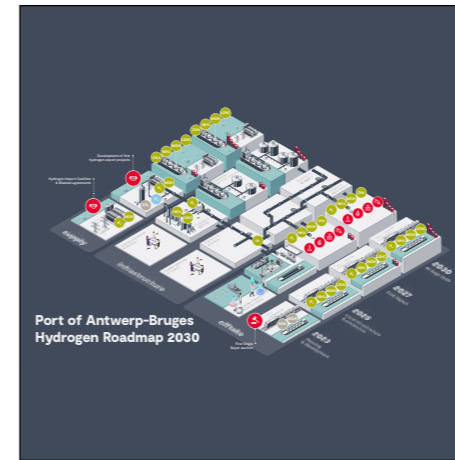

○Research & Training ●Production ●Transport, dist & storage ○Technology ○Engineering & integration ○Application ●End User

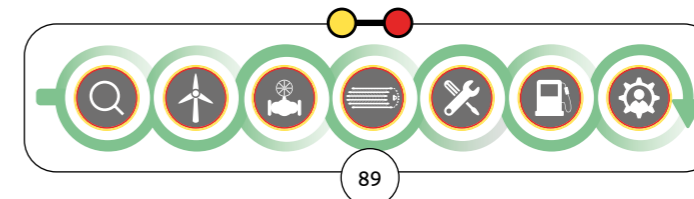



remeha

Remeha
www.Remeha.be
Yves Vanpoucke
yves.vanpoucke@remeha.be

Our activities

Remeha brings you heat and domestic hot water comfort and focuses on making a difference when it comes to sustainability and efficiency. Remeha wants to provide a variety of flexible and future-proof solutions. As it's our belief that there are multiple roads to sustainability and the reduction of CO2 emissions.

One of these roads and an alternative to natural gas is green hydrogen. We are currently working on making our entire range of residential and commercial boilers in Europe 100% hydrogen-ready. Most of the boilers in our current portfolio are already 20% hydrogen-ready. And we will launch a conversion kit for future boilers, enabling them to switch from natural gas to 100% hydrogen.

At the moment we are working on multiple residential and commercial pilot projects with 100% hydrogen-ready boilers. In the Netherlands Remeha achieved a world premier with the introduction of hydrogen boilers to heat 13 homes over the existing gas grid. This new way of heating was warmly welcomed by the residents. The results prove that hydrogen can be a good alternative, particularly for homes that are difficult to insulate and for which electric heat pumps do not offer a solution, or in areas where no heat network can be constructed.

Our link with hydrogen

- Remeha brings you heat and domestic hot water comfort and wants to provide a variety of flexible, sustainable, and future-proof solutions. That's why, next to our hybrid solutions and heatpumps, we strongly believe in the benefit of our hydrogen boilers.



○Research & Training ○Production ○Transport, dist & storage ●Technology ○Engineering & integration ●Application ○End User

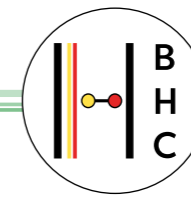
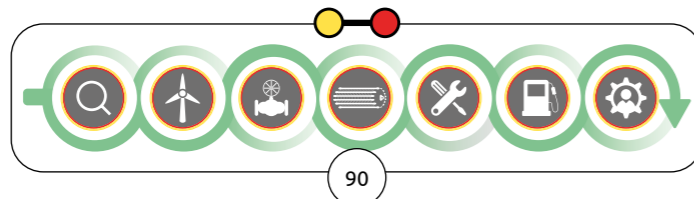

RESA

RESA
<https://www.resa.be/>
Simon Lachi
simon.lachi@resa.be

Our activities

RESA operates in 73 municipalities, with over 14,000 kilometres of electricity grid and more than 4,000 kilometres of gas networks, and is thus the main Distribution Network Operator (DNO) for electricity and gas in the province of Liège.

Our link with hydrogen

- Our gas network could carry blended hydrogen without the need for major adaptations.
- Our expertise in operating gas networks will enable us to develop a hydrogen distribution network if this proves relevant.

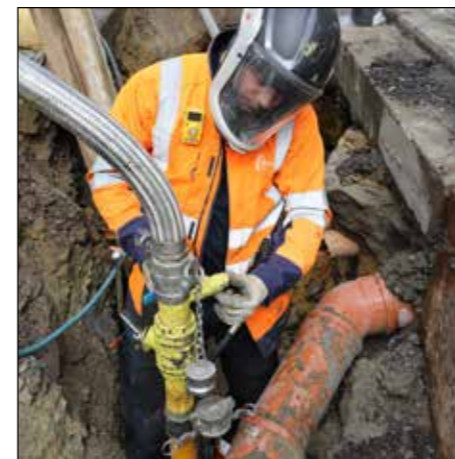

○Research & Training ○Production ●Transport, dist & storage ○Technology ●Engineering & integration ○Application ○End User

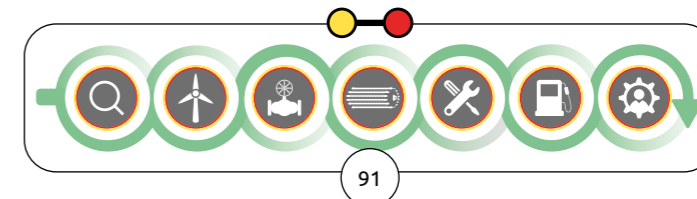



KdG Expert
Karel de Grote Hogeschool

Research Centre Sustainable Industries -
Karel de Grote University of Applied Science and Arts
<https://www.kdg.be/en/research>
Kris Martens
kris.martens@kdg.be

Our activities

- The Research Centre Sustainable Industries (RSCI) has 3 focus points:
- data science for industry - optimization of industrial processes and products using AI based algorithms
 - sustainable energy and mobility - alternative fuels and electrification
 - circular industry - remanufacturing of mechatronics and valorisation of organic waste streams

Within its focus point 'Sustainable energy and mobility', the RSCI has over 10 years of experience with hydrogen. At the beginning this research focussed on retrofitting a car (VW Caddy) and a spindle to run on 100% hydrogen. At the moment, flex fuel/multifuel systems are being constructed, allowing engines to run on hydrogen, methanol and/or (bio)diesel. The focus of the research is on heavy duty applications, i.e. marine engines and engines for industrial applications. A unique, high-end test bench setup allows the RSCI to monitor engine performance and exhaust characteristics at the same time. Based on this data, economical models are built to identify the tipping point for companies to invest in a multifuel system.

The RSCI works together with companies on a one-on-one basis (contract research) or via collective research projects (subsidized research).

Our link with hydrogen

- Research on hydrogen in multifuel systems, focussing on heavy duty applications (marine engines and industrial applications)



○Research & Training ○Production ○Transport, dist & storage ●Technology ●Engineering & integration ●Application ○End User

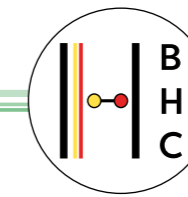
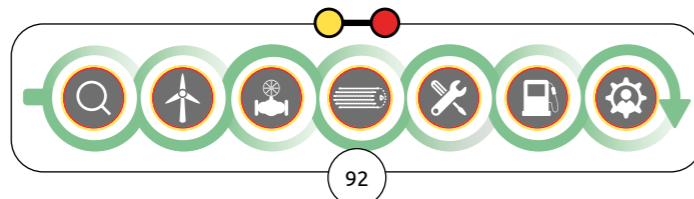

R.STAHL ELECTROMACH B.V.
www.r-stahl.com
Geert Wouters
Geert.Wouters@r-stahl.com

Our activities

R. STAHL ELECTROMACH is an international leading design company with experienced engineering and manufacturing, expertise in explosion-proof components and control systems. These components or systems can be applied in areas where gas and dust explosions may occur. Therefore, we are the obvious partner for oil, gas, petrochemical, Hydrogen and offshore applications.

Hydrogen energy may be clean and powerful, but it's not without hazards. H2 requires a very low level of energy to ignite – in fact, only a tenth of the energy that gasoline needs. It burns extremely hot, with a flame that's invisible to the human eye. It also combusts extremely quickly, building up enormous explosive energy. That's why hazardous areas can be found in any location where Hydrogen is present – whether it's being made, transported, stored or used.

R. STAHL has the technologies that prevent Hydrogen from being a hazard. We are certified to install our products and solutions around the globe. We customize your solutions to your precise requirements, whatever they may look like. So go ahead and make the world GREEN. We'll be there to support you and make it safe.

Our link with hydrogen

- R.STAHL ELECTROMACH supplies Explosion protection components, systems and solutions for the Hydrogen supply chain.



○Research & Training ○Production ○Transport, dist & storage ●Technology ○Engineering & integration ○Application ○End User

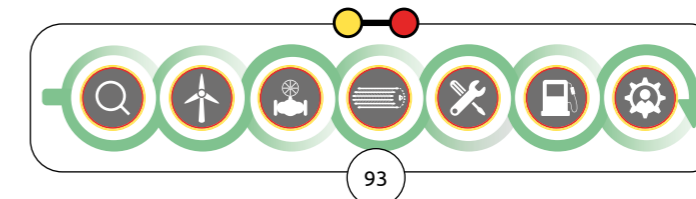



SEA-Tank Terminal

SEA-Tank Terminal
www.sea-tankterminal.com
Georges Leysen
georges.leysen@sea-tankterminal.com

Our activities

SEA-Tank Terminal is an independent tank storage company operating 8 terminals in the ports of Ghent and Antwerp.

The company is specialized in the development of innovative tailor made terminals.

Specialized storage is being offered for a wide range of products including chemicals, vegetal and mineral oils.

Next to these products the company has also focused on the handling and storage of alternative, durable products including fame, UCO and HVO.

Our link with hydrogen

- SEA-Tank Terminal is preparing for the future, where hydrogen will play a very important role and is looking for opportunities to develop storage for hydrogen or hydrogen carriers.



○Research & Training ○Production ●Transport, dist & storage ○Technology ○Engineering & integration ○Application ○End User

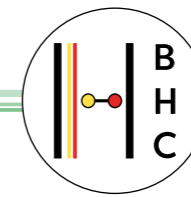
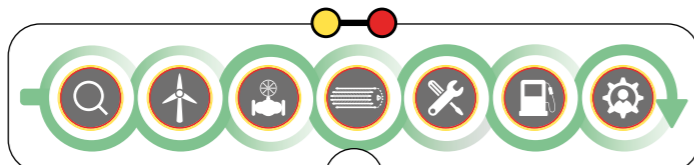

sck cen

Exploring a better tomorrow

SCK CEN
www.sckcen.be
Chris Lefrère
chris.lefrere@sckcen.be

Our activities

EXPLORING A BETTER TOMORROW

We are constantly exploring. And have been since 1952. Driven by our passion for nuclear technology and empowered by our unique infrastructure. SCK CEN explores the limits of the possible. In this way, we continuously expand our knowledge in various nuclear fields. But no matter how many directions we explore, we always have the same goal in mind: developing innovative nuclear applications for a better world. Why? Because we are convinced that we can make a gigantic difference with one of the smallest elements on Earth – the atom. Both now and in the future. For people and nature. Read on and you will discover exactly how we do it.

SMR-LFR

SCK CEN has been researching reactor concepts of the future for many years and, since 2022, this has also included Small Modular Reactors (SMR). Lead Fast Reactors (LFR), cooled by lead, could become an indispensable link in a sustainable energy supply. With support from the Belgian Government, Phase 1 for building a demonstrator SMR-LFR at SCK CEN in Mol has started.

Our link with hydrogen

- SMR-LFRs with solid oxide electrolysis or thermochemical water splitting is a promising combination allowing the production of 'low carbon' or 'clean' hydrogen at a competitive cost with current low cost carbon technologies. In the ZEHYNE project, SCK CEN is looking for partnerships in developing advanced non-electrical applications as part of its SMR-LFR program (Zero Emission Electricity, Hydrogen, Heat and other applications produced with Nuclear Energy).

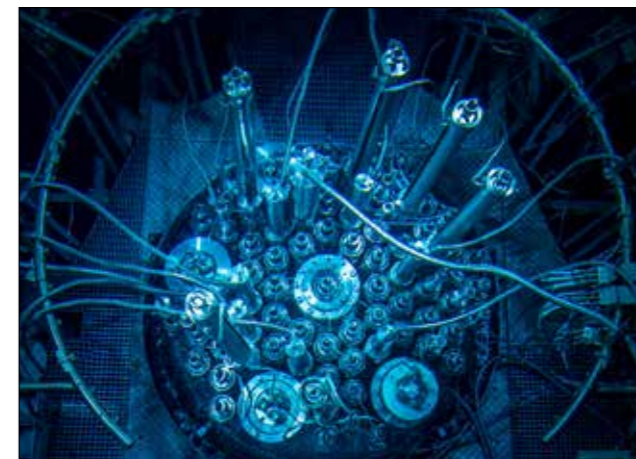

○Research & Training ●Production ○Transport, dist & storage ○Technology ○Engineering & integration ○Application ○End User

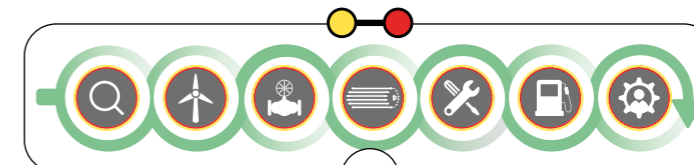



SGS Belgium NV
 www.sgs.com
 Mark Philips
 mark.philips@sgs.com

Our activities

SGS is the world's leading testing, inspection and certification company, the global benchmark for sustainability, quality, and integrity. Our 98,000 employees operate a network of 2,650 offices and laboratories, working together to enable a better, safer, and more interconnected world.

Our broad spectrum of hydrogen services includes:

- Industrial safety: functional, explosion and fire safety with comprehensive testing for material reliability and safety
- Health, safety, and environment: industrial hygiene, occupational and construction safety, environmental testing for air, soil, and water – both on- and off-site
- Testing and advisory: from NDT (Non-Destructive Testing) to corrosion, leakage, purity, and electrical testing
- Consulting and supervision: complete your project on time and on budget, while meeting all relevant regulations and quality standards.
- Auditing and compliance: including GHG (Greenhouse gas) emissions and guarantee of origin
- Supply chain quality inspection: ensure the safety and efficiency throughout your hydrogen fuel supply chain
- Extensive support at every stage: technical staffing, measurements, calibration, fuel retail, gas analysis, cyber security, and training services.

Our link with hydrogen

- Our emphasis on safety, combined with our extensive expertise, will ensure that the transition to the hydrogen economy is both smooth and secure for all stakeholders. SGS helps organizations, large and small, through the energy transition. We support customers to work towards achieving the overall net-zero target and creating a safer environment based on green energy production.



○Research & Training ●Production ●Transport, dist & storage ●Technology ○Engineering & integration ●Application ○End User

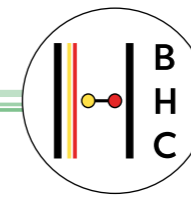
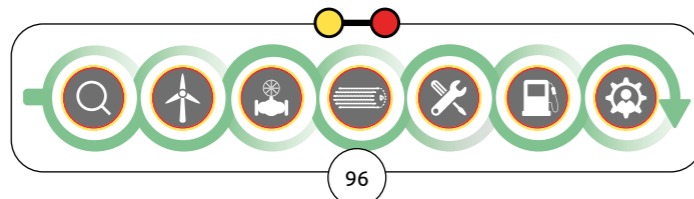

SIEMENS
 www.siemens.com
 Johan De Blicck
 johan.de_blicck@siemens.com

Our activities

Siemens develops innovations that advance society, with a focus on electrification, automation and digitalization.

Siemens' activities are divided into three parts: Digital Industries (DI), Smart Infrastructure (SI) and Mobility (trains and trams).

Siemens Digital Industries is a leading player in innovation and technology in the field of automation and digitalization. In close collaboration with our partners and customers, we are the driving force behind the digital transformation in the manufacturing and process industries.

Smart infrastructure from Siemens intelligently connects energy systems, building technology and industries to technologically guide the changing way we live and work.

Siemens' products, solutions and services related to electrification, automation and digitalization play a crucial role in the hydrogen sector.

Our link with hydrogen

- Siemens is a provider of core components for electrification, automation and digitalization. With our hydrogen-enabled portfolio, we serve process OEM, EPC and end customers to build and operate equipment modules or entire plants along the hydrogen value chain.



○Research & Training ○Production ○Transport, dist & storage ●Technology ●Engineering & integration ●Application ○End User

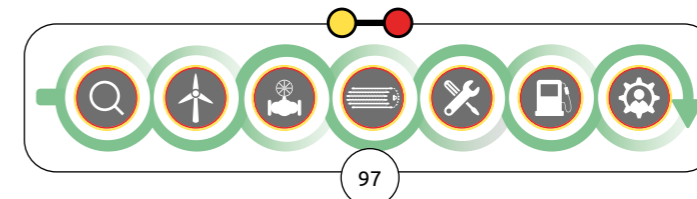



Siemens Energy
www.siemens-energy.com/global/en/priorities/future-technologies/hydrogen.html
Wim Van Den Mosselaer
wim.van_den_mosselaer@siemens-energy.com

Our activities

Siemens Energy is an integrated energy technology company, with 92,000 dedicated employees, present in more than 90 countries. We offer products, solutions, and services along the entire energy value chain.

We focus on the following three pillars to meet net zero:

1. Generate power with low- or zero-emissions: 42% of global emissions come from power generation. From efficient and hydrogen-ready gas turbines to wind, we have technologies to cut emissions now.
2. Transport and store energy efficiently: It's going to take eight times more renewable generation and grid connection to reach net zero by 2050 (source: World Energy Outlook 2022). Our transmission and storage technologies create a reliable backbone.
3. Reduce emissions in industrial processes: Industry needs to reduce emissions by five gigatons per year. Electrification, automation, and digitalization will be key.

We are addressing these three pillars with our respective Business Areas: Gas Services, Siemens Gamesa, Grid Technologies, and Transformation of Industry.

Our link with hydrogen

- Siemens Energy is an electrolyser manufacturer and a solution provider in the entire 'Power-to-X' value chain – from wind parks through power transmission, large-scale industrialization of water electrolysis, as well as compression, transport, storage, and hydrogen-based power and heat generation.



○ Research & Training ● Production ● Transport, dist & storage ● Technology ● Engineering & integration ● Application ○ End User

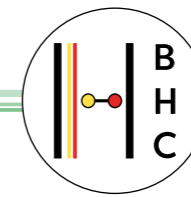
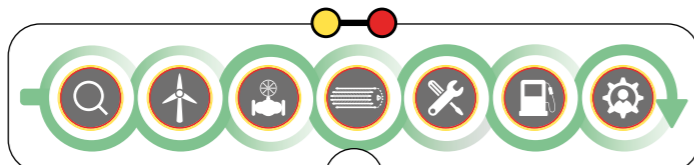

Sirris
www.sirris.be
Pieter Jan Jordaens
pieterjan.jordaens@sirris.be

Our activities

Sirris helps companies achieve their innovation ambitions with hands-on support. They can count on the efforts of a multidisciplinary team of 150 experts, more than 200 partners, ecosystems, a wide range of industrial labs and tons of inspiration. In this way, together with the companies, we realise some 1,300 innovation projects a year.

The Sirris department Energy Transition Industries supports companies across the entire value chain with their RD&I projects. Typical goals are lowering the levelized cost of hydrogen (LCOH), scaling up manufacturing capabilities, and increasing the sustainability of hydrogen production units. Benefit from our expertise to get your research, development, testing or demonstration project on track.

Sirris operates also the largest climatic test chamber in Europe for functional testing in extreme climatic conditions.

Of course your equipment or machines should be capable of reliably operating in often challenging climatic conditions. That is exactly what we validate in our unique testing facilities where you can get confirmation of your equipment's performance and reliability in different worldwide (extreme) climatic conditions.

Our link with hydrogen

- Sirris is committed to lowering the levelized cost of (green) hydrogen, scaling up production units, and exploring new technologies. And we support our customer in testing and validation campaigns according several standards or according to your specific needs, which may include (extreme) cold or hot ambient temperatures, high or low humidity, ice formation, sun radiation, etc.



● Research & Training ● Production ● Transport, dist & storage ● Technology ● Engineering & integration ● Application ○ End User

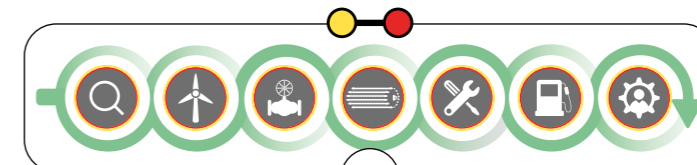



Smart Hub - Provincie Vlaams-Brabant
<https://www.smarthubvlaamsbrabant.be/>
 Pierre Faché
 pierre.fache@vlaamsbrabant.be

Our activities

- Smart Hub Flemish Brabant is a governmental organization.
- Smart Hub Flemish Brabant is a concentration of tech clusters in Belgium.
- Our hallmark technologies focus on health, food, logistics, cleantech, media and creative industry.
- Smart Hub Cleantech has blossomed into cutting-edge technology used for sustainable energy production, smarter energy consumption, circular materials, mobility and industrial processes.
- Smart Hub Flemish Brabant bets on networking and collaboration. Innovative projects from the collaborations are supported with grants. We're also active on branding our region & actors and internationalization.

Our link with hydrogen

- For hydrogen we unite a whole range of actors from tech providers, pioneering users to facilitators.

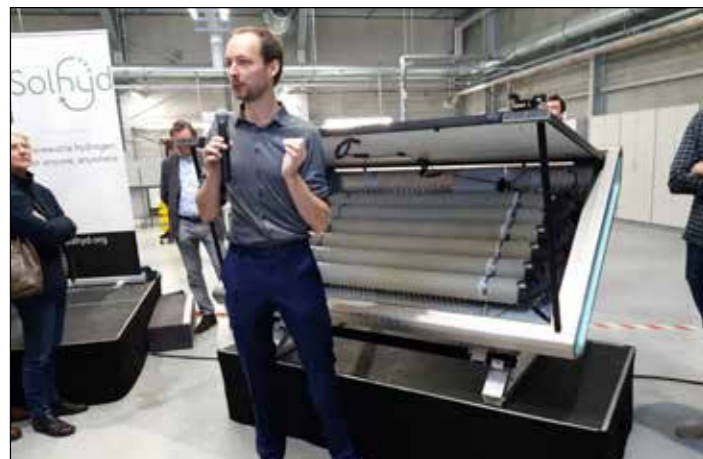

○Research & Training ○Production ○Transport, dist & storage ○Technology ○Engineering & integration ●Application ○End User

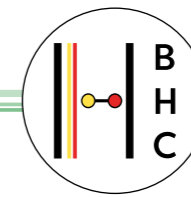
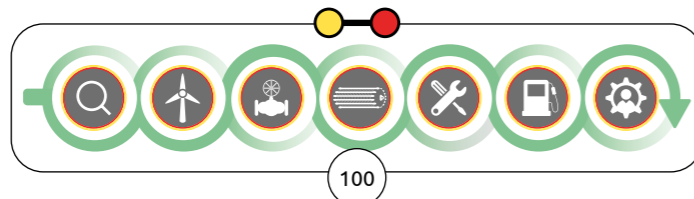

Smulders
www.smulders.com
 Jef Dijckmans
 jef.dijckmans@smulders.com

Our activities

- Smulders is an international steel construction company with facilities in Belgium (Arendonk, Balen and Hoboken), the Netherlands, Poland and the UK. Smulders focuses on civil and industrial projects and offshore wind energy. We are involved in the construction of buildings, bridges, high-voltage pylons and other projects throughout the energy transition, but dominantly, for offshore wind farms. Thanks to our many years of experience, we are involved in projects all over the world and are the market leader in Europe in terms of building the foundations and substations for offshore wind projects.
- Our subsidiary lemans can participate in the engineering, production, assembly and mounting on the green- or brownfield for general steel constructions. We work on individual volumes of 500 to more than 10,000t for each project.
- Our passion for steel can only grow in a safe and environmentally friendly environment. We therefore want to make a strong contribution to such an environment. Not only through our renewable energy activities, but also by ensuring that our companies operate safely and sustainably.
- Smulders has been focusing more on CO2 management since 2014. We use the CO2 Performance Ladder to map our energy consumption and help reduce our CO2 emissions.
- Over a five-year period, all our branches switched to 100% green and locally produced electricity. Thanks to the green energy and our other actions, our carbon footprint per working hour has already decreased by 60% since 2014.

Our link with hydrogen

- As an esteemed supplier to the offshore wind industry, Smulders provides foundations (transition pieces, jackets, floating foundations) for offshore windmills as offshore high-voltage substations for offshore wind farms. In 2023, we completed our first floating foundations and, in that way, there is an opportunity to prepare an installation of an electrolyser on board of these constructions pending on circumstances at sea!



○Research & Training ○Production ○Transport, dist & storage ○Technology ●Engineering & integration ●Application ○End User

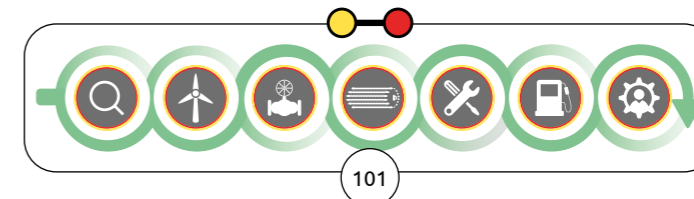



Solenco Power NV
 www.solencopower.com
 Sven Duchatelet
 sven.duchatelet@solencopower.com

Our activities

Solenco is a fast-growing Belgian SME innovator in the field of cleantech and specializes in hydrogen energy storage systems for residential, commercial and industrial installations.

Our link with hydrogen

- Solenco is a fast-growing Belgian SME innovator in the field of cleantech and specializes in hydrogen energy storage systems for residential, commercial and industrial installations.

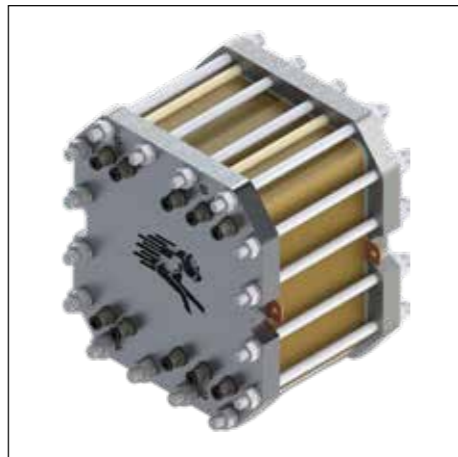

○Research & Training ○Production ○Transport, dist & storage ●Technology ●Engineering & integration ●Application ○End User

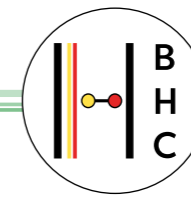
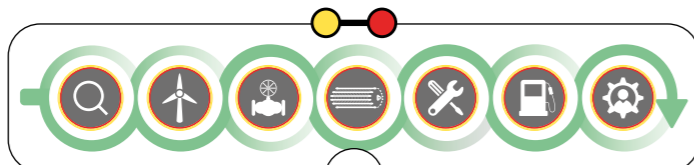

Solhyd
 https://solhyd.org/
 Jan Rongé
 jan@solhyd.org

Our activities

Solhyd is a tech startup known for its hydrogen panels. These are solar modules which directly produce hydrogen from sunlight and water captured from air. Hydrogen panels produce renewable hydrogen at any scale, anywhere, without the need for liquid water or a power supply. They don't contain noble metals. Due to their modularity, the installation can scale along with your local hydrogen needs.

Solhyd is a spin-off of KU Leuven university. We are currently up-scaling the technology and setting up collaborations with integration partners for various end uses and markets. Hydrogen panels are ideal for SMEs and pilot projects at this stage. By 2030 we target large-scale projects for industrial end uses.

Our link with hydrogen

- Solhyd develops and produces unique hydrogen panel technology to produce hydrogen directly from sunlight and air.



○Research & Training ●Production ○Transport, dist & storage ●Technology ●Engineering & integration ○Application ○End User

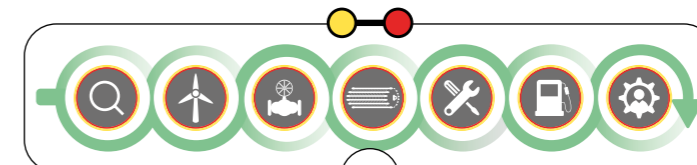



Somarine
 www.somarine.be
 Amedée Somers
 info@somarine.be

Our activities

We are a service provider for inland shipping companies.

Our link with hydrogen

- We want to look in the possibilities to buy a ship to convert to a barge and supply it with green energy to sail



○Research & Training ○Production ●Transport, dist & storage ○Technology ○Engineering & integration ○Application ○End User

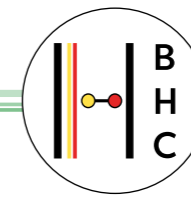
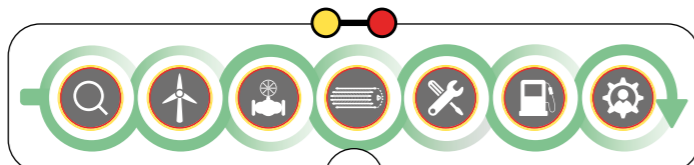

SPIE
 spie.be
 Jean Aerts
 j.aerts@spie.com

Our activities

SPIE Belgium is a subsidiary of the SPIE Group, European market leader in multi-technical services in the field of energy and communication. SPIE Belgium has 12 branches in Belgium and 1 in Luxembourg and employs 1,700 people.

The company is divided into 5 divisions: Industry, Building Projects, Building Services, Infrastructure and ICS. SPIE is fully immersed in renewable energies and related techniques such as storage.

The company already provides services to the hydrogen sector and wants to focus even more on hydrogen technology.

Our link with hydrogen

- SPIE assists in the manufacturing of electrolyzer components, SPIE installs and integrates hydrogen equipment, SPIE performs mechanical, piping and electrical work.

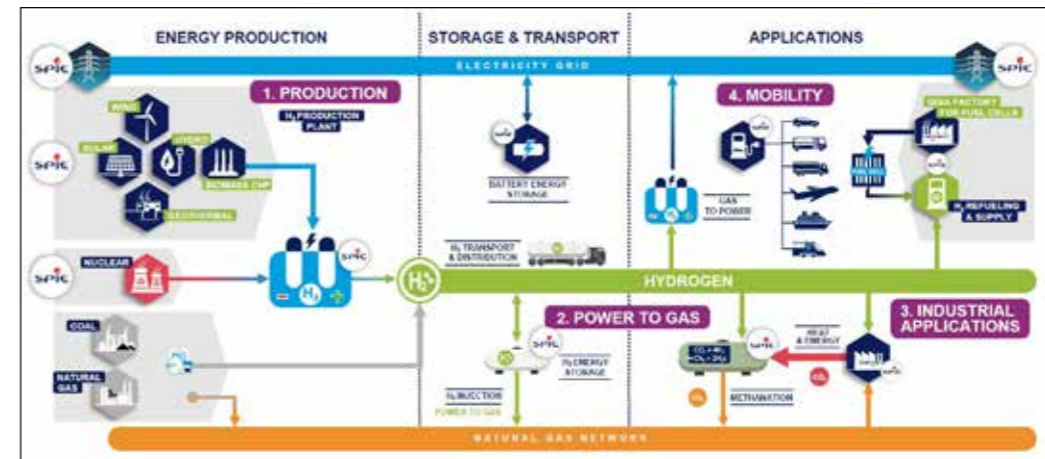

○Research & Training ○Production ●Transport, dist & storage ○Technology ●Engineering & integration ○Application ○End User

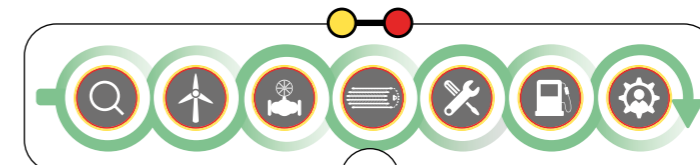



Swagelok
Swagelok Belgium

Swagelok Belgium
www.swagelok.com/en/industries/clean-energy
Olivier Bravin
olivier.bravin@swagelok.com

Our activities

Swagelok supports the evolution of hydrogen as a clean energy source and enables alternative-fuel vehicles to run on hydrogen. From the lab to the field, we work with global customers to help them safely and efficiently reach their goals for clean energy production, distribution, compression, refueling, and mobility applications.

Swagelok offers high-performance, leak-tight products and tailored services to meet the toughest clean energy application requirements, including:

- Safe storage and transfer at high pressures to deliver the desired energy densities and operational ranges
- Consistent delivery of critical components, assemblies, and custom solutions that keep projects on schedule
- Design services for safe and reliable fluid systems
- Onsite services to help attain optimal performance from fluid systems
- Variety of trainings on tube fittings, tube bending, orbital welding, hydrogen tube systems, and many more

Our link with hydrogen

- Swagelok's 75 years of experience in the containment and management of hazardous fluids and small-molecule gases under pressure makes us unique. Today we offer products, solutions, and services engineered and delivered specifically to meet the needs of companies engaged in the pursuit of environmentally safe and sustainable energy business opportunities.



○Research & Training ●Production ●Transport, dist & storage ●Technology ●Engineering & integration ●Application ○End User

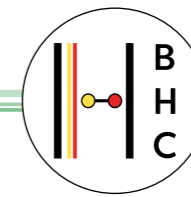
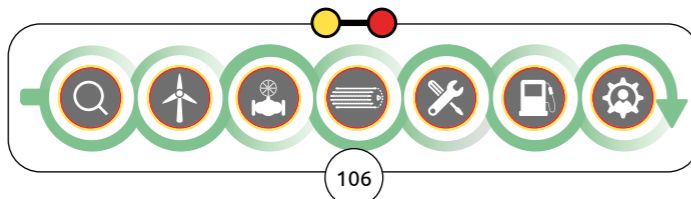

SWECO

Sweco
www.swecobelgium.be
Sara VanderBeken
sara.vanderbeken@swecobelgium.be

Our activities

At the forefront of the global green revolution, Sweco's team of architects, engineers and experts co-creates solutions that transform societies. Our comprehensive services span across various sectors: from energy, industry and water to buildings, urban development and transportation infrastructure.

What sets us apart is our unwavering commitment to the entire hydrogen value chain. We specialize in hydrogen supply, transportation, and distribution, extending our expertise to meet diverse hydrogen demands. Our services encompass a spectrum of offerings including feasibility studies, permitting, conceptualization, basic engineering, and EPCm services, tailored to clean hydrogen production and green molecules, conversion of existing import facilities, storage solutions, pipeline networks, process optimizations, and new plant innovations.

Recognized by Reuters as one of the Top 10 Innovators in Clean Hydrogen, our success story is built upon a rich portfolio of impactful projects: the feasibility study, design and environment impact assessment of the hydrogen backbone in the port of Antwerp and Ghent, conceptual engineering of a 20MW water electrolysis unit and hydrogen purification unit in Norway, concept and permitting for a 260MW

Our link with hydrogen

- Transforming societies, Sweco has an unwavering commitment to the entire hydrogen value chain. Our services encompass a spectrum of offerings including feasibility studies, permitting, conceptualization, basic engineering, and EPCm.



○Research & Training ○Production ○Transport, dist & storage ○Technology ●Engineering & integration ○Application ○End User

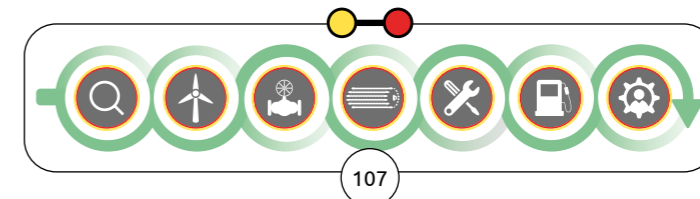



Technifutur®
<https://technifutur.be/>
 MARCHAL Cendrine
 cendrine.marchal@technifutur.be

Our activities

Created in 1992, Technifutur® is the largest vocational training center in Wallonia (Belgium) with 3 main domains of activities: Numerical, Industry and Mobility.

Technifutur®, through its pole "Mobilty", works on hydrogen training since 2014.

First, Hydrogen was considered as one of the alternatives to fossil fuels in the automotive sector, then, specific training has been developed in 2018 (through the participation to a FP7 FCHJU project on Hydrogen training program) which permits to develop a training for the automotive technicians.

Nowadays, the development of training on other fields of activities of the hydrogen sector are approached.

Our link with hydrogen

- Technifutur® organize vocational training for all target groups (workers, jobseekers, schools). Hydrogen is one of the topics in our catalogue as well as electro mechanics, welding, piping, industrial maintenance which are also related to Hydrogen sector.



○Research & Training ○Production ●Transport, dist & storage ●Technology ○Engineering & integration ●Application ○End User

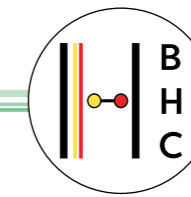
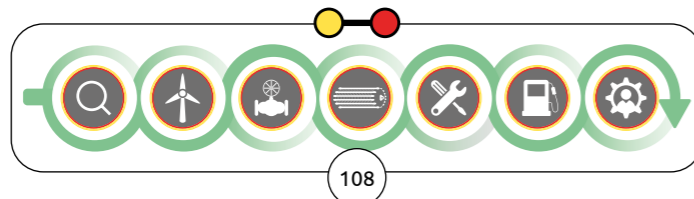

Technogas NV - Gas Systems
www.technogas.be
 Laurent Alloo
 lal@technogas.be

Our activities

Technogas specializes in the design, sale and installation of hydrogen refueling stations and gas regulating and metering installations, offering tailor-made solutions across various sectors. Their expertise spans natural gas, biogas, hydrogen, and other specialty gases, providing reliable gas infrastructure for industrial applications.

General Activities:

- Gas Regulating and Metering Stations: Technogas designs, installs, and services gas stations, ensuring safety, efficiency, and sustainability in industrial applications.
- Hydrogen Refueling Stations: A key part of their hydrogen activities is the development, supply and servicing of hydrogen refueling stations to meet the growing demand in the car industry, heavy transport and industrial sectors. Technogas partners with Ataway, a market leader in hydrogen refueling technology, to deliver reliable and scalable solutions.
- Biogas Upgrading Installations: Technogas also offers biogas upgrading systems that convert raw biogas into renewable natural gas.
- With a dual focus on traditional gas systems and hydrogen activities, Technogas is a key player in the energy transition, driving the adoption of sustainable and renewable gases.

Our link with hydrogen

- Technogas is committed to promoting hydrogen as a key component in the energy transition, focusing on the development of hydrogen refueling stations and expansion stations integrating advanced technologies to support clean mobility and industrial applications.



○Research & Training ○Production ●Transport, dist & storage ○Technology ●Engineering & integration ○Application ○End User

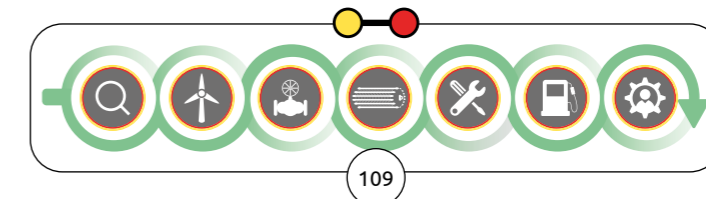



TECHNORD Belgium
 www.technord.com
 Thierry Fabritius
 technord@technord.com

Our activities

The Technord industrial group specializes in the integration of industrial projects in electricity (Low, Medium and High Voltage, Connected Power), Automation and Process Control, Industrial IT and MES/MoM, and Industry 4.0 technologies (Internet of Things-IoT, Data Science & Analytics, Digital Twin, Artificial Intelligence) to guarantee optimal productivity and flexibility (and even predictability) of its clients' industrial processes. Technord supports its customers throughout the entire project life cycle, from detailed design to commissioning (including abroad). Technord's customers include world leaders in the internet, champagne, cement, lime, agri-food, pharmaceuticals, cosmetics, renewable energy (wind turbines, photovoltaic panels, hydrogen cogeneration plants), aeronautics, metals, and more. Founded in 1945 in Tournai (Belgium), where its head office is located, the family-owned Technord Group now employs more than 400 staff and as many subcontractors, and has a turnover of around €120 million, 25% of which is generated outside Europe. The Technord group operates worldwide and is developing an international presence through its 12 subsidiaries. Technord is a certified partner of the world's leading manufacturers.

Our link with hydrogen

- As a member of the Tweed Cluster and as part of our business development initiative to help our customers realize their future hydrogen production, storage and distribution projects, we offer comprehensive and flexible solutions. Our approach draws on the expertise of all our departments, from industrial electricity (HV/LV) to automation and SCADA for the command and control of hydrogen installations, via Data Science (prediction models, modelling, data correlation, etc.). And let's not forget our expertise in EMS (Energy Management System and optimization) integration.

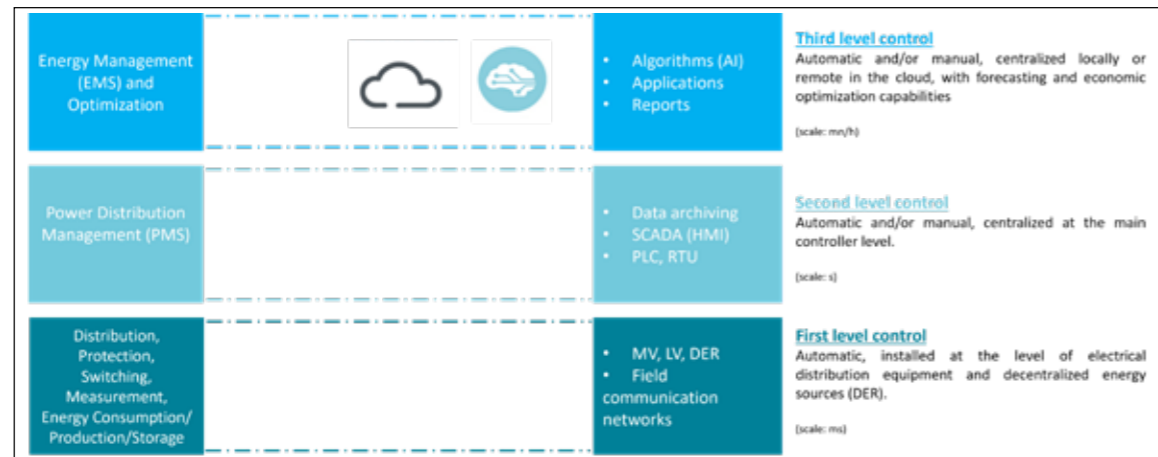

○Research & Training ○Production ○Transport, dist & storage ○Technology ●Engineering & integration ○Application ○End User

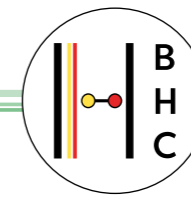
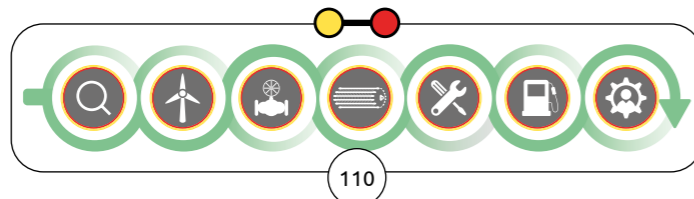

Thema SA
 www.thema-sa.be
 Michael Bauraing
 michael.bauraing@thema-sa.be

Our activities

THEMA SA est spécialisé dans la conception de solutions énergétiques personnalisées, alliant innovation, technologie et service sur mesure. Nous collaborons étroitement avec les bureaux d'études et les installateurs pour offrir des solutions adaptées. Grâce à notre approche multimarques, nous importons les meilleurs éléments pour concevoir la solution optimale : pompes à chaleur, biomasse, cogénération, installations solaires, production d'eau chaude sanitaire et chaudières à condensation. Notre équipe d'ingénieurs et de techniciens hautement qualifiés met son expertise technique à votre service, de l'étude du projet à la maintenance. Faites-nous confiance pour réduire votre consommation énergétique !

Our link with hydrogen

- Importation de matériel HVAC fonctionnant à l'hydrogène «H2-ready» : chaudières condensation, cogénération, ...



○Research & Training ○Production ○Transport, dist & storage ●Technology ●Engineering & integration ○Application ○End User

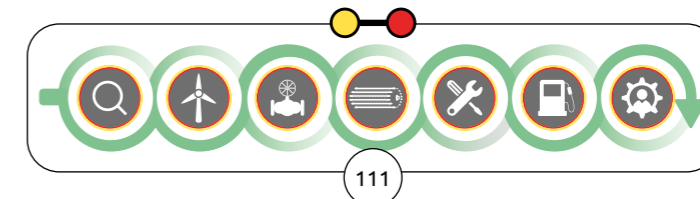

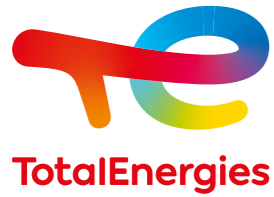

TotalEnergies
<https://totalenergies.com/>
 Sasa Marinic
sasa.marinic@totalenergies.com

Our activities

About TotalEnergies TotalEnergies is a global multi-energy company that produces and markets energies: oil and biofuels, natural gas and green gases, renewables and electricity. Our more than 100,000 employees are committed to energy that is ever more affordable, cleaner, more reliable and accessible to as many people as possible.

Active in nearly 130 countries, TotalEnergies puts sustainable development in all its dimensions at the heart of its projects and operations to contribute to the well-being of people.

For TotalEnergies, hydrogen is a key alternative fuel for tomorrow's sustainable mobility, in particular for heavy transport. Since the Company opened its first hydrogen refueling station in Germany in 2002, it has been working to develop H2 infrastructure for mobility directly and through partnerships.

Our link with hydrogen

- TotalEnergies announced in February 2023 together with Air Liquide a joint venture that aims to deploy more than 100 hydrogen stations for heavy duty vehicles on major European roads – mainly in France, Benelux and Germany – in the coming years. The Company is also part of the H2 Mobility joint venture, which operates hydrogen stations in Germany, Austria and Switzerland. In France, the Company holds a stake in HysetCo, which develops hydrogen stations and operates H2 light vehicle fleets such as taxis in the Ile-de-France region.



○Research & Training ●Production ●Transport, dist & storage ●Technology ●Engineering & integration ●Application ●End User

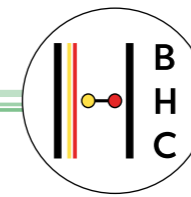
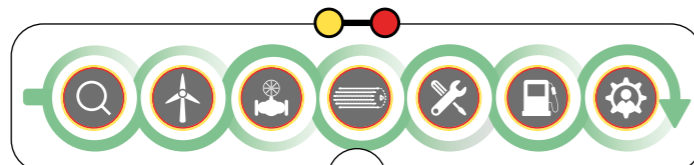

Tractebel Engineering S.A.
<https://tractebel-engie.com/en/our-hydrogen-solutions>
 Sven GOETHALS
sven.goethals@tractebel.engie.com

Our activities

Tractebel is a global engineering company delivering game-changing solutions for a carbon-neutral future. Insights gathered during our more than 150 years of experience in energy and infrastructure projects combined with local expertise allow us to tackle complex green hydrogen projects.

For Tractebel, green molecules are key enablers to decarbonize industry and transport and massive energy carriers to trade renewable energy. We have been providing for several years green hydrogen solutions to industries, utilities and project developers to help them on their hydrogen projects: from renewable energy to green hydrogen, ammonia and e-fuels production, transport and storage. We have already commissioned MW-scale solutions and we now actively work on large utility projects.

We optimize energy solutions in function of regional renewables resources, electrical grid characteristics, energy/molecule demand profile and best available technologies (batteries, gas storage, heat storage, hydrogen, process licensors, etc.) and give full engineering support from project inception, feasibility, smart-FEED, tendering to realization based on multi-disciplinary teams with specific green hydrogen and e-molecule expertise.

Our link with hydrogen

- We provide a holistic approach in close collaboration with our client to optimize the Levelised Cost of Hydrogen / e-molecule with in-depth knowledge of hydrogen and energy in general. We ensure smooth project realization and mitigate project risks with first-hand experience on all project phases and blocks up to GW-scale, with experience with all electrolyser manufacturers and process licensors, with recognized high voltage expertise ensuring stability of electrical grids and with special focus on H&S in design.

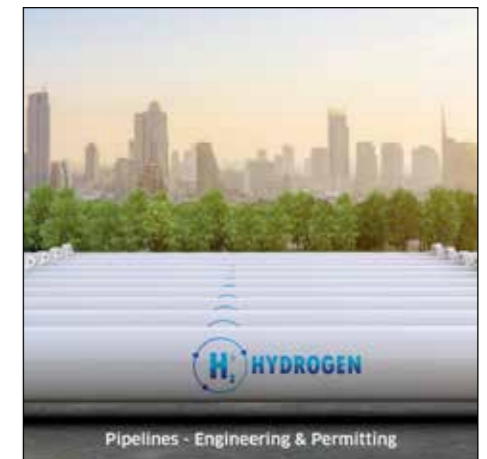
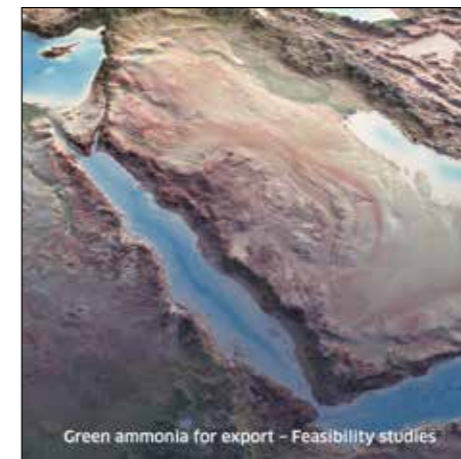

○Research & Training ●Production ●Transport, dist & storage ○Technology ●Engineering & integration ●Application ○End User

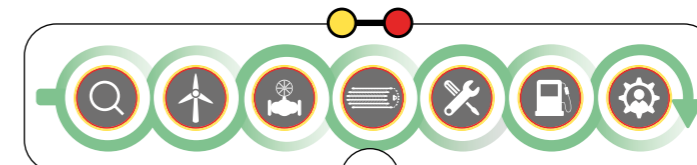



ULB
<https://chemsin.ulb.be/home/>
 François Reniers
 francois.reniers@ulb.be

Our activities

ChemSIN (formerly Chani) is a research service of the Faculty of Sciences. It brings together 4 academics, 30 researchers, 4 technicians and 1 secretary. Research activities focus on the chemistry of atmospheric plasmas (F. Reniers), Catalysis (T. Visart), electrochemistry (T. Doneux) and nanoelectrochemistry (J. Ustaroz).

The studies cover various aspects of the chemistry of surfaces and interfaces since they relate to the modification, characterization and study of the reactivity of surfaces.

These studies carried out at the solid-solution interface and at the solid-gas interface relate to the modification of surfaces (metals, metal electrodes and polymers) by chemical or electrochemical means, by self-assembly as well as by plasma techniques.

Thin films, organized monolayers and nanostructured surfaces can thus be produced and characterized. Characterizations involve the use of a wide range of advanced (nanoscale) electrochemical methods, spectroscopy, microscopy, as well as contact angles.

The surface properties are evaluated mainly in connection with the development of "intelligent" materials, biosensors and electrocatalysis (environmental electrochemistry, batteries, fuel cells, electrolysis), electro dialysis, biocompatibility, development of barrier layers,...

Our link with hydrogen

- Developpement and experimentation of hydrogen production (new H₂ water electrocatalyst, atmospheric and electrolysis plasma, new catalysts for the steam reforming of methane and water gas shift). Production and characterization of thin layers for fuel cells and for the storage and transport of ammonia

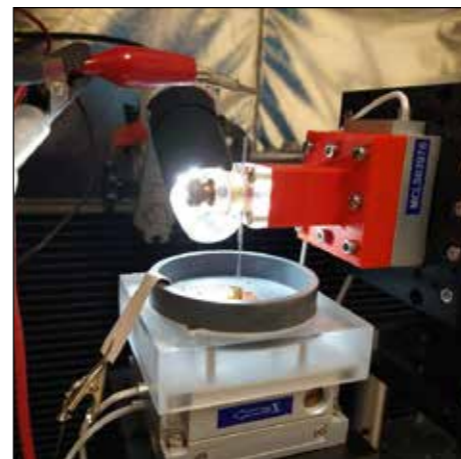
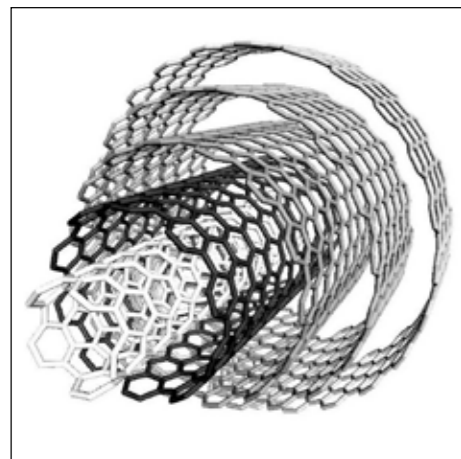

● Research & Training ● Production ● Transport, dist & storage ○ Technology ○ Engineering & integration ● Application ○ End User

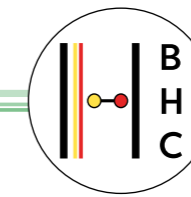
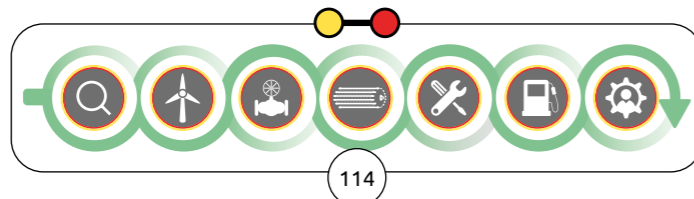

UMICORE
<https://fcs.umicore.com/en/fuel-cells/why-fuel-cells/>
 Dr Fabrice STASSIN - Government Affairs
 fabrice.stassin@umicore.com

Our activities

Umicore is a global materials technology and recycling group. It focuses on application areas where its expertise in materials science, chemistry and metallurgy makes a real difference. Its activities are organized in three business groups: Catalysis, Energy & Surface Technologies and Recycling. Umicore generates the majority of its revenues and dedicates most of its R&D efforts to clean mobility materials and recycling.

Umicore's PEM catalysts are developed to provide the automotive industry with high performance fuel cells and to enable green hydrogen production through electrolysis. With 30 years' experience of manufacturing PEM catalysts, Umicore has proven know-how in catalyst development, scale up and industrial scale production, as demonstrated by Umicore solutions already on the road in vehicles.

At Umicore's recycling facilities, the critical metals (platinum-group metals - PGMs) contained in electrocatalysts can be recovered and re-injected into the hydrogen economy. The excellence and quality of the services and catalysts we provide to support our customers during the entire product development process and product lifecycle have been regularly recognized by awards from major Fuel Cell manufacturing companies.

Our link with hydrogen

- Umicore is a key global player in innovation and manufacturing electrocatalysts for PEM fuel cells and electrolyzers. Umicore is a key global player in the recovery of platinum group metals through its Hoboken-based recycling activity.

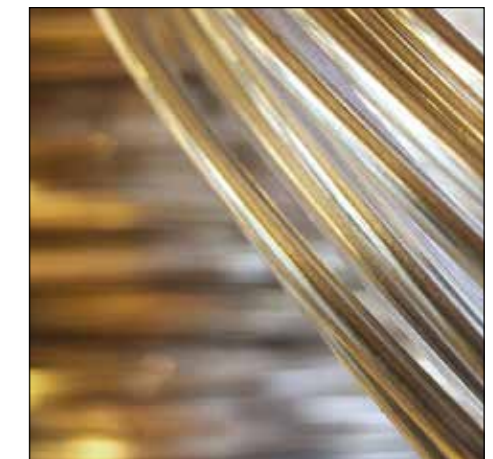

○ Research & Training ○ Production ○ Transport, dist & storage ● Technology ○ Engineering & integration ○ Application ○ End User

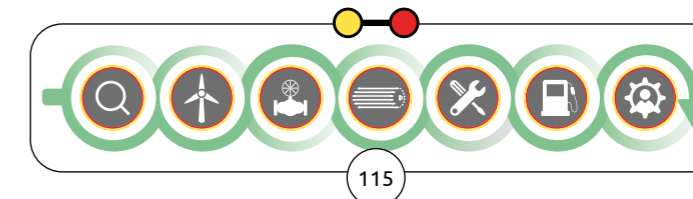



UMONS
University of Mons

UMons
<https://web.umons.ac.be/trmi/en/home/>
Ward De Paepe
ward.depaepe@umons.ac.be

Our activities

Thermal Engineering and Combustion Unit (TRMI) is the laboratory that brings together all research and teaching activities of the UMONS around heat transfer, and combustion. By specializing our research activities on energy in buildings and industry, as well as its sustainable production, we contribute to tackling the engineering challenges of today and tomorrow: Towards sustainable energy for all!

More specifically, the expertise of the research group can be found in the modelling, designing, and experimental testing of novel small-scale, highly-flexible and efficient, carbon-clean solutions towards sustainable cogeneration in decentralized applications, with a particular focus on micro gas turbines.

Our link with hydrogen

- Numerical expertise and limited experimental expertise for hydrogen combustion in industrial micro gas turbine combustors, including flame studies, the impact of dilution, design of 100% hydrogen combustors, ...

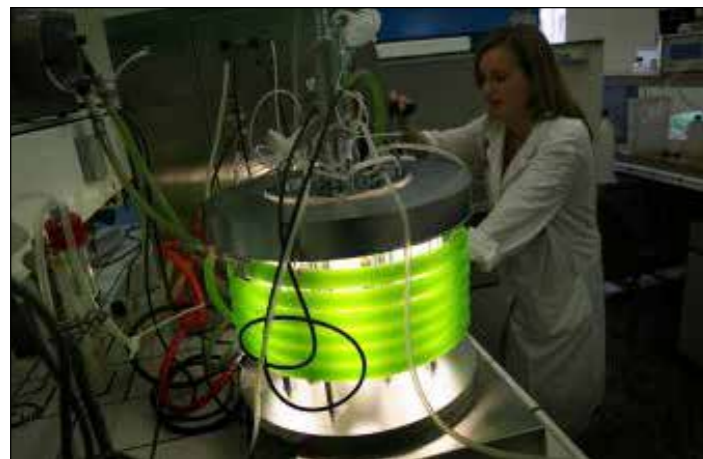

● Research & Training ○ Production ○ Transport, dist & storage ● Technology ○ Engineering & integration ○ Application ○ End User

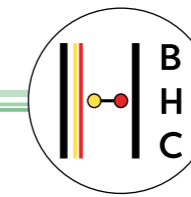
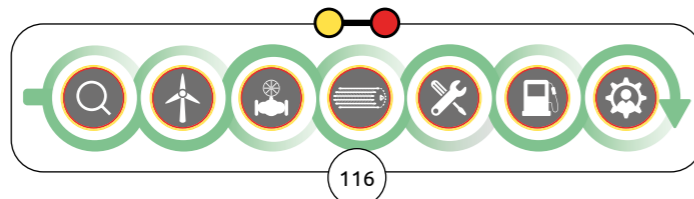

UCLouvain

Université catholique de Louvain - UCLouvain
<https://uclouvain.be>
Matthieu Palate
matthieu.palate@uclouvain.be

Our activities

UCLouvain is the first French-speaking university in Belgium. It welcomes nearly 40,000 students in eight locations in Wallonia and Brussels. UCLouvain is a research university, recognised for the excellence of its contributions to the development and transmission of knowledge. The hydrogen activities of UCLouvain are mainly research and development activities in the following areas:

- Hydrogen production by hydrolyse, steam methane reforming, chemical looping combustion and reforming
- Development and analyses of new material for hydrogen transportation and storage: new metal alloy, metal and chemical hydrides
- Physical and mechanical metallurgy of several engineering alloys (hydrogen embrittlement)
- Study of impact of renewable energy source on power grids operation
- Energy systems: micro and macro levels to understand what are the key drivers to help us succeed the energy transition
- Energy Return on Investment of renewable energy and its impact on the society
- Hydrogen sensor (electronic) development
- Development of high-performance materials for: catalytic conversion of green hydrogen; storage of green hydrogen produced intermittently; converting electricity into H₂ (electrodes).

Our link with hydrogen

- Research and development of new solutions for hydrogen: production, storage, transportation, measurement and management.



○ Research & Training ● Production ● Transport, dist & storage ● Technology ○ Engineering & integration ○ Application ○ End User

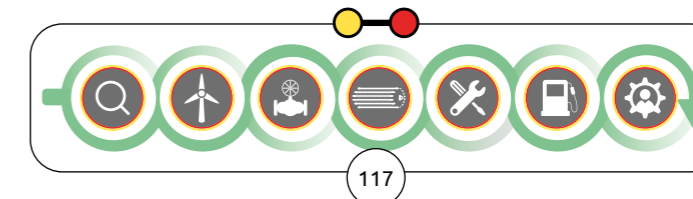



Université de Liège
www.uliege.be
Laurence Druet
l.druet@uliege.be

Our activities

Production

- Study of hydrogen production from renewable resources (plant materials, organic wastes, industrial by-products, and end-of-life plastics) by thermochemical approaches
- Process modeling for hydrogen production technologies

Transport

- Transmission network: Feasibility study of a global-grid, IP through the use of hydrogen

Use

Conversion and storage

- Development of low temperature fuel cell catalysts
- Assembly and characterization of PEM fuel cell materials (catalysts, membranes, bipolar plates) on instrumented single-cell test benches
- Characterization of PEM fuel cell stacks on instrumented test bench
- Process modeling of fuel switching to hydrogen for different industrial sectors
- High flux processability of innovative ceramic materials for (green) hydrogen production and storage

Power to X

- Use of hydrogen for CO₂ hydrogenation reactions, incl. power-to-fuel and power-to-kerosene
- Process modeling and optimization, incl. techno-economic assessment and process design
- Experimental design of pilot-scale benches for CO₂ capture and re-use (CO₂-to-kerosene)

Vehicles

- Design, optimization and simulation techniques for the study and design of electrochemical storage and conversion systems

Our link with hydrogen

- Researchers at ULiège are very active in the hydrogen field throughout the whole value chain ; Production, Transport and Use.



● Research & Training ○ Production ○ Transport, dist & storage ○ Technology ○ Engineering & integration ○ Application ○ End User

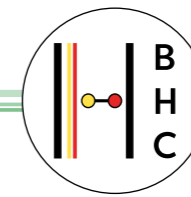
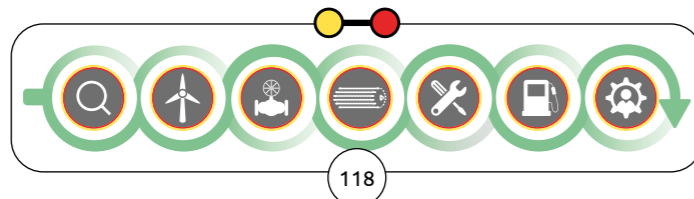

University of Antwerp
<https://www.blueapp.eu/en>
Quinten Van Avondt
quinten.vanavondt@uantwerpen.be

Our activities

University of Antwerp is a leading research driven university located at the heart of the second largest chemical cluster in the world. Hydrogen research at UAntwerp focuses on sustainable production processes and hydrogen carriers. Research group ELCAT works on (photo-)electrochemical production of hydrogen (carriers) with a focus on component and reactor development and in-house developed flow-electrolyzers (alkaline and proton-exchange).

Furthermore, research group DuEL designs chemical reactors for the storage and release of H₂ to and from liquid and solid carriers, following process intensification, and researches the production of H₂ from abundant sources (e.g. seawater) or waste streams. Thirdly, research group PLASMAN develops technology for plasma-based CH₄ conversion into H₂ and into higher hydrocarbons (e.g., ethylene, acetylene) and oxygenates next to plasma-based dry reforming of methane for the production of syngas and other value-added chemicals and fuels.

Finally, these process developments are supported by the materials expertise of research group LADCA, who design heterogeneous catalysts for in-situ hydrogen production as well as porous materials with tuned properties as matrix for hydrogen clathrates.

Our link with hydrogen

- We develop cutting edge hydrogen process technologies based on electrolysis, plasmalysis and traditional thermocatalysis. We are looking for company partners in the hydrogen value chain interested in collaborations on these topics.

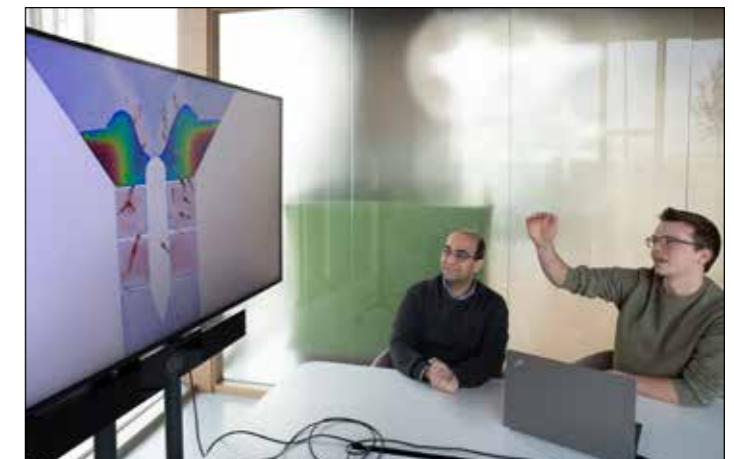

● Research & Training ● Production ● Transport, dist & storage ● Technology ○ Engineering & integration ○ Application ○ End User

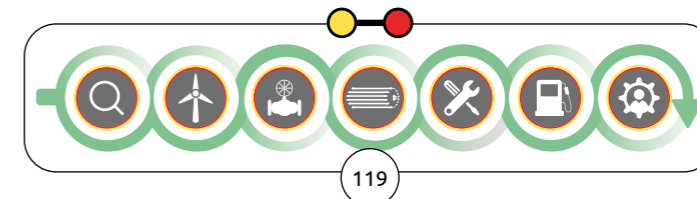



University of Namur - LARN, LCMFM & RCO
<https://www.unamur.be/>
 Prof. Stéphane Lucas
stephane.lucas@unamur.be

Our activities

LARN has extensive expertise in the deposition of high-performance thin films by vacuum method (PVD) and ion beam analysis. Over the past decade, they have developed unique know-how in the deposition and characterization of thin films using state-of-the-art equipment and combining experiments and theoretical simulation. Understanding the growth modes and physico-chemical properties of films is at the core of research activities while solving technical problems of companies in various fields, including hydrogen technologies:

- Evaluation of the degradation of mechanical performance in various metallic materials subjected to very high hydrogen fluxes by IBA
- Study the performance of lithium targets under very high hydrogen fluxes
- Characterization of hydrogen into material by ion beam analysis
- Coating for fuel cells and electrolyzers electrodes
- Development of new plasma product/process in relation to energy production and storage.

LCMFM models the mechanical properties of new polymer-composite solutions and the process of diffusion of H₂ in these structures while the RCO group is implementing hydrogenation processes using frustrated Lewis pairs organic catalyst.

Our link with hydrogen

- LARN, a cutting-edge research laboratory at UNamur, excels in thin film deposition and analysis, leveraging state-of-the-art equipment to enhance surface performance across diverse applications, including engineering, optics, medicine, and mechanics, with a focus on hydrogen technologies and innovative plasma processes for energy production and storage.

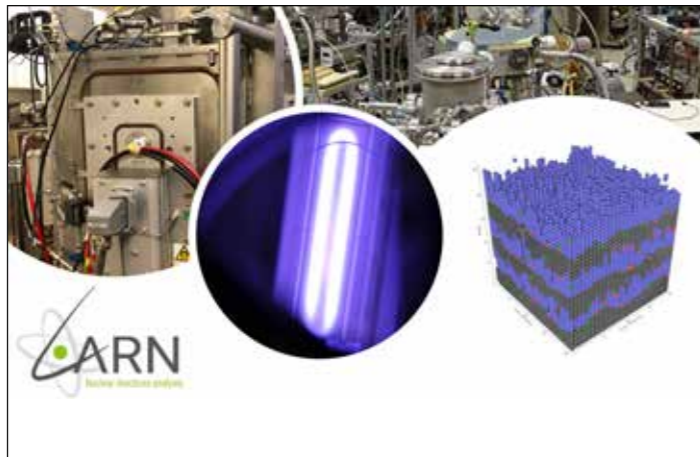

● Research & Training ● Production ● Transport, dist & storage ○ Technology ○ Engineering & integration ○ Application ● End User

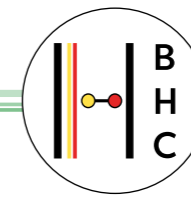
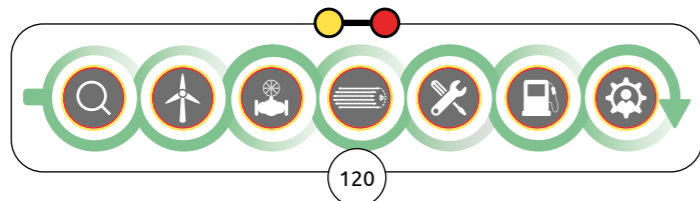

Virya H2
<https://www.virya-energy.com/>
 Merlijn Erbuer
merlijn.erbuer@viryah2.com

Our activities

Virya H2, a pioneering force in sustainable hydrogen generation, is dedicated to a wide spectrum of activities, including development, funding, construction, and operation of sustainable hydrogen production facilities.

We are actively developing megawatt-scale electrolysis facilities in Belgium, the Netherlands, and Germany. Our primary objective is to supply sustainable hydrogen to industries and heavy mobility facing substantial decarbonization challenges, facilitating a seamless transition to sustainable energy sources.

With over a decade of experience, Virya H2 has achieved milestones in hydrogen production, distribution, and end-user applications. Our achievements include a 1 MW hydrogen production demonstrator in Halle, integrated refuelling stations providing public access to renewable hydrogen, and the introduction of 44-ton heavy-duty hydrogen-powered trucks in logistics.

Our operational expertise encompasses on-site production of sustainable hydrogen through water electrolysis, utilizing both PEM and alkaline technologies. We possess specialized knowledge across various mobility applications, from heavy-duty vehicles to buses, inland waterways, and maritime.

We are member of the Virya Energy group, a leading Belgian-based sustainable energy conglomerate. Our mission is to expedite the global energy transition by scaling innovative technologies across the energy landscape. Our group is active in onshore wind, rooftop solar, renewable energy services (including GEO XYZ and Fluves), and sustainable mobility (DATS 24). Our installed capacity approaches 500 MW, spanning renewable energy generation sites in Belgium, France, Poland, Portugal, and India.

Our link with hydrogen

- Virya H2 is active in the development, construction and operation of renewable hydrogen production sites, including the distribution towards the end user.



○ Research & Training ● Production ● Transport, dist & storage ○ Technology ○ Engineering & integration ○ Application ○ End User

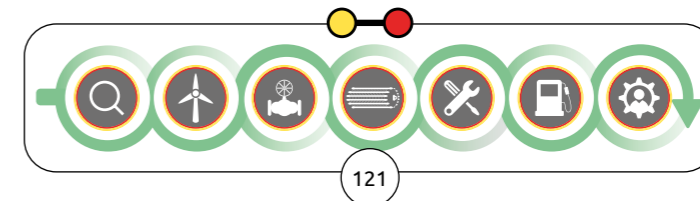



VIVES University of applied sciences
 www.vives.be
 Sam Schotte
 sam.schotte@vives.be

Our activities

VIVES University of applied Sciences is located in West - Flanders and provides higher education and research.

The Centre of Expertise 'Smart Technologies' is a multidisciplinary cluster of researchers working in the field of new and innovative technologies. With a clear focus on applied research with an expertise in sustainable techniques and eco-design, trying to find the most environmental positive solution. The research group not only has knowledge of the different sustainable techniques, but also management skills so the products and services are analyzed and balanced not only from technological point, but also from ecological, economical, legal and social ethical perspective. The research group hydrogen established a hydrogen infrastructure for testing of hydrogen technologies. VIVES is operating a green hydrogen production unit with compressed storage, a setup for testing internal combustion engines, a fuel cell test installation and a chassis dyno with a fuel cell vehicle. Insights and knowledge gained from projects are used to improve education and to disseminate to companies and their employees in order to facilitate a faster transition towards a sustainable net zero future.

Our link with hydrogen

- Research with focus on integration and dissemination of hydrogen technology for SME's, education and broad public



● Research & Training ● Production ○ Transport, dist & storage ● Technology ● Engineering & integration ○ Application ○ End User

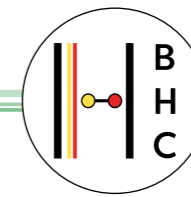
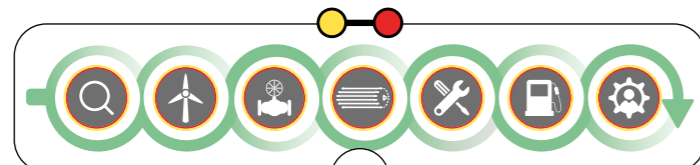

VK Architects & Engineers
 vk-architects-engineers.com
 Rein Borgoo
 rein.borgoo@vk-architects-engineers.com

Our activities

VK architects+engineers®, part of Sweco is a multidisciplinary design agency with “out of the box” and long-term thinking in its genes. For the past 70 years, they used their ingenuity and multidisciplinary teams to design sustainable solutions. Proof points are the many projects in healthcare, industry, infrastructure and buildings. The office has grown to more than 600 employees, spread over Belgium, the Netherlands, Luxembourg, Spain and the United Kingdom.

Since 2020, VK architects+engineers has once again taken the leading role in the sector with the introduction of its full lifecycle approach: even more future-oriented thinking, by focusing on strategic partnerships with customers and stakeholders throughout the entire life cycle of its realizations, including the ‘after construction phase’.

We believe there is only one planet. Our footprint is much larger than we ever realized. Sustainability will be the driving force to success. ‘Building as usual’ no longer will be the driving force to success. Our sustainability coaches are there to guide you towards your sustainable design ambitions: CO2 neutral materials & buildings, water neutrality, circularity of materials & structures, human centered design, ...

Our link with hydrogen

- We need to keep up to date of the ever-growing possibilities and techniques for applying hydrogen so that we can respond properly and correctly to the ever-growing questions surrounding the implementation of hydrogen gas and this in both building-related and industrial projects.

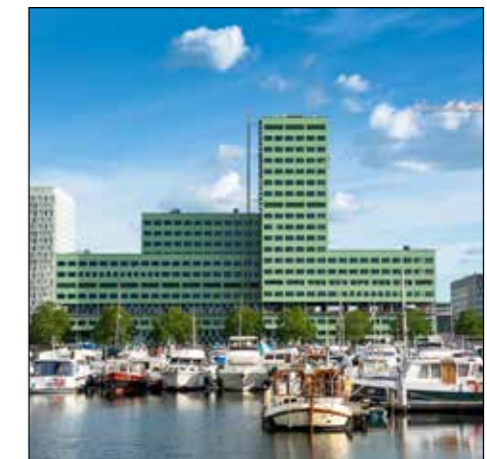

○ Research & Training ○ Production ○ Transport, dist & storage ○ Technology ● Engineering & integration ○ Application ○ End User

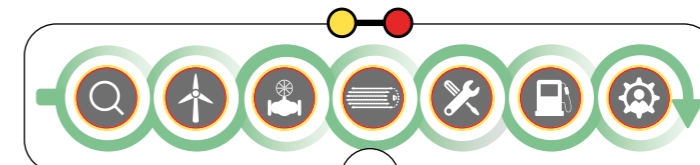



VTTI BV
www.vtti.com
Xander Japin
xja@vtti.com

Our activities

For over 18 years, VTTI has been a global leader in independent energy storage and now develops critical energy infrastructure needed to move towards a carbon neutral future. Fueled by its purpose, 'Energy to Move Tomorrow,' the company safely provides and expands access to essential energy, including fuels, chemicals, gasses, and other energy derived products and accelerates the transition to sustainable sources for customers and partners. VTTI's headquarter is in Rotterdam, the Netherlands, and the company is owned by Vitol, IFM Investors and ADNOC.

To support large-scale hydrogen imports, VTTI has launched Project Amplify. Our first two projects are in the Port of Antwerp and the Port of Rotterdam, where we plan to build ammonia import terminals and crackers. These projects are on track to provide clean hydrogen to various sectors and industries across Europe as early as 2029. The European Commission has identified Amplify Antwerp and Amplify Rotterdam as Projects of Common Interest for the European Union, meaning they are considered a key priority to interconnect Europe's energy infrastructure.

Our link with hydrogen

- VTTI's ambition is to build a European network of ammonia import terminals and crackers in key ports that will feed into the hydrogen backbone system – the pipeline network that will run throughout Europe. Customers will be able to store their ammonia in our tanks, in the form of cold liquid. At the right moment, they can provide ammonia to our cracker to be decoupled. Their hydrogen can then be injected into the pipeline system.



○Research & Training ○Production ●Transport, dist & storage ○Technology ○Engineering & integration ○Application ○End User

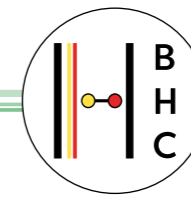
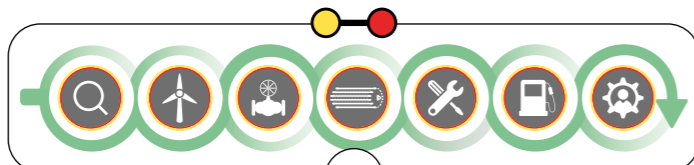

Wallonie-Entreprendre
<https://www.wallonie-entreprendre.be/>
Pascal LEHANCE
pascal.lehance@wallonie-entreprendre.be

Our activities

WE aims to support the entrepreneurial fabric in order to stimulate the creation of values in Wallonia. It supports the growth of businesses with a view to creating long-term jobs, added value and sustainability.

WE raises awareness of major issues, such as the energy transition, innovation or the digitalization of economic activity by offering a whole range of financial solutions. It supports companies at all stages of your development.

WE supports the self-employed, traders, entrepreneurs, managers of SMEs and VSEs, cooperators, CEOs of large companies. We support all forms of organization, from their creation to their transmission.

Our link with hydrogen

- As part of the transition, hydrogen is a pillar in which to invest. Wallonie-Entreprendre can help with the financial closing of complex projects by limiting the financial risk for investors.



○Research & Training ○Production ○Transport, dist & storage ○Technology ●Engineering & integration ○Application ●End User

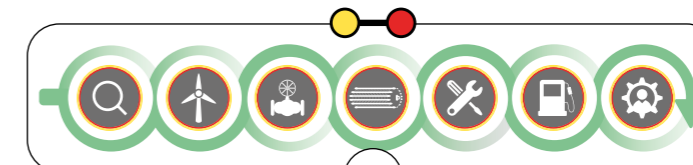



WaterstofNet

www.waterstofnet.eu

Contact: bert.decolvenaer@waterstofnet.eu

Our activities

WaterstofNet is a knowledge and collaboration platform. We contribute to a carbon-neutral society by supporting and realizing hydrogen projects in the Benelux. Together with the industrial partners, research institutes and governments, we enable concrete achievements in the field, laying the basis for further collaboration. By doing so, we assist in the further development of the Benelux as a leading hydrogen region.

Our activities are based on the following four pillars:

- **Ecosystem:** Together with Cluster Tweed we unite the Belgian hydrogen industry in the Belgian Hydrogen Council (BHC). We coordinate and realize the activities of the Council. WaterstofNet also coordinates the Waterstof Industry Cluster (WIC), an hydrogen ecosystem of over 165 members in the Benelux.
- **Projects:** WaterstofNet initiates and coordinates national and international hydrogen projects. Over the past 14 years we were involved in many projects on different applications (industry, infrastructure, vehicles and built environment). This has led to a lot of hands-on experience.
- **Advisor to governments:** WaterstofNet is a partner for the Benelux governments supporting their hydrogen visions and framework. Especially with the Flemish government WaterstofNet has a structural collaboration.
- **Knowledge Center:** WaterstofNet develops roadmaps makes studies for governments/companies. Yearly we organize the 'Hydrogen Academy'. Dedicated speakers talk about existing and future hydrogen technologies, applications, policies and regulations.

Our link with hydrogen

- WaterstofNet is a knowledge and collaboration platform, that coordinates the Waterstof Industrie Cluster and the Belgian Hydrogen Council. It also coordinates and realizes European hydrogen projects.

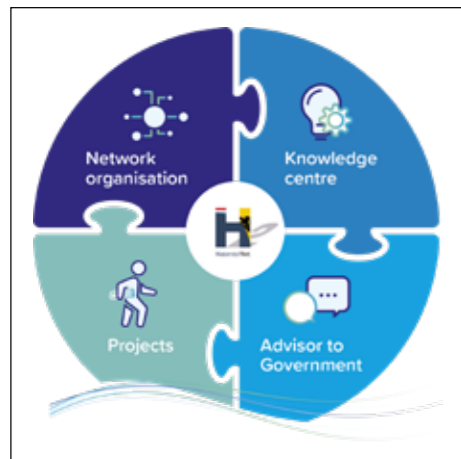

○Research & Training ○Production ○Transport, dist & storage ○Technology ○Engineering & integration ○Application ○End User

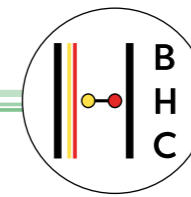
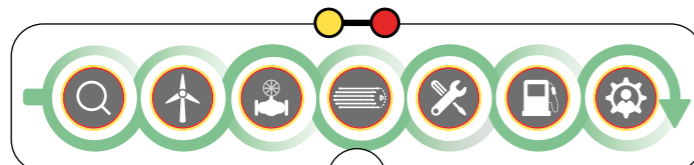

Cluster TWEED

<https://clusters.wallonie.be/tweed/fr>

Cédric Brüll

conseil@clustertweed.be

Our activities

TWEED's priority is to encourage investment and innovation in the energy and water sectors by mobilising companies (private and public), research, innovation and training players, as well as government and administrative authorities, around projects. The goals of the TWEED and H₂O clusters are as follows:

- **Networking :** To provide a meeting place to facilitate contacts and exchanges of experience, and to enable energy and water players to get to know each other better
- **Mapping :** To understand and raise awareness of the sectors, markets and players involved in all the value chains of the energy and water sector
- **Innovation :** To identify and support industrial and investment projects in particular, through partnerships and by aiming to strengthen commercial links, and to access innovative capacity and a higher threshold of competitiveness
- **International :** Promote the expertise of cluster members at national and international level
- **Partnerships :** To promote the sharing of knowledge and the exchange of good practice, including at international level, and to encourage synergies with other groupings, clusters and competitiveness clusters in the energy and water sector
- **Knowledge Centre :** To position itself as a recognised centre of expertise and a reliable partner for stakeholders (private or public) concerned by the environmental challenges of energy and water

Our link with hydrogen

- TWEED along with political decision-makers, industrial players, R&D players and universities has created «H2Hub Wallonia». This ecosystem enable all players to position themselves in the H₂ value chain. In particular, it is open to producers, consumers and infrastructure providers in order to stimulate the use of green hydrogen in Wallonia.

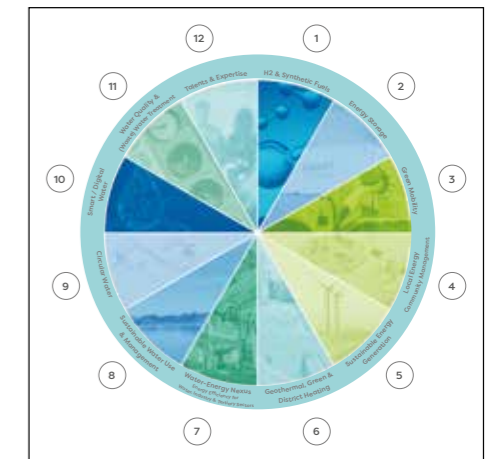

○Research & Training ○Production ○Transport, dist & storage ○Technology ○Engineering & integration ○Application ○End User

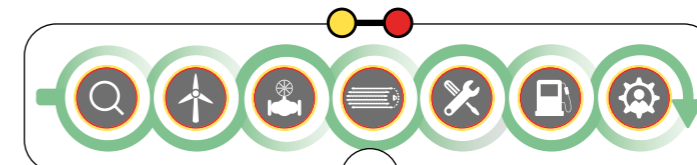

Associated partners

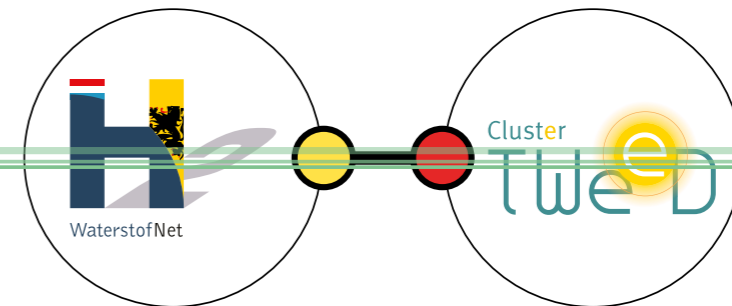

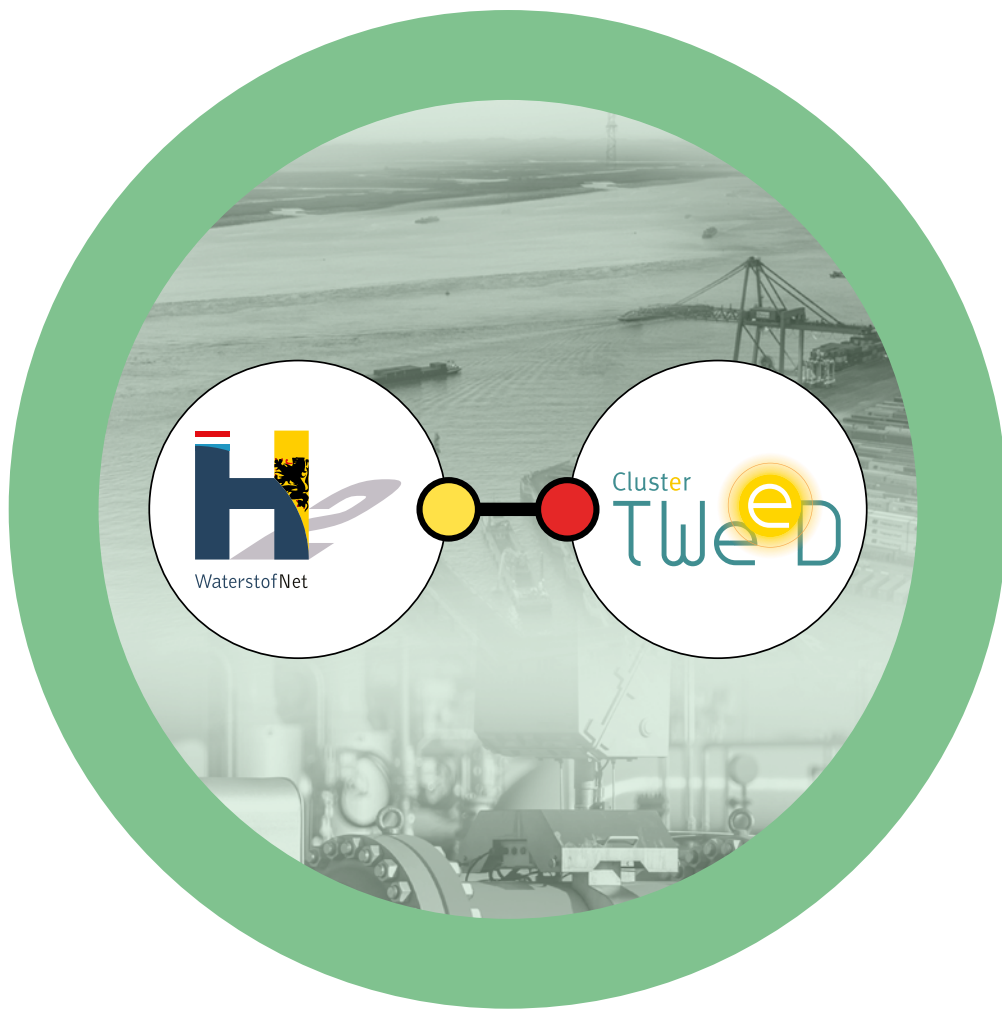

Program office

www.waterstofnet.eu

www.clustertweed.be

Contact: info@waterstofnet.eu

Contact: info@clustertweed.be

Open Manufacturing Campus
Slachthuisstraat 112 bus 1
2300 Turnhout

Centre Afnis
Clos Chanmurly 13
4000 Liège

Telnr +32 (0)14 40 12 19

Tél. : +32 (0) 4 358 17 00

